



## VGA INTERFACE CONTROLLER FOR TFT PANEL

**Model: DT-1920-VGA**

Part number : P/N 41775000X-3 or up

## INSTRUCTIONS

### CONTENTS

Page:	<b>2. Introduction, How to Proceed, Usage Note, Disclaimer</b>
	<b>3. System design</b> – Diagram of a suggested system
	<b>4. Assembly notes</b> – Important information about system elements
	<b>6. Connection &amp; Operation</b> – How to use the controller
	<b>10. Connectors, pinouts &amp; jumpers</b> – Essential connection information
	<b>17. Controller dimensions</b>
	<b>18. Application notes</b>
	<b>20. Troubleshooting</b>
	<b>21. Specifications</b>
	<b>22. Appendix I – Mode Support Table</b>
	<b>23. Appendix II – RS-232 control protocols</b>
	<b>28. Appendix III – DDC/CI support at Display port</b>
	<b>29. Appendix IV – Mapping definition</b>
	<b>31. Appendix V - Auto Color Gain</b>
	<b>32. Appendix VI – DV remote control unit work for DT-1920-VGA</b>
	<b>33. Appendix VII – Light sensor function work for DT-1920-VGA</b>
	<b>34. Appendix VIII - Temperature sensor function work for DT-1920-VGA</b>
	<b>36. Warranty, Caution &amp; Limitation of Liability, Trademarks</b>
	<b>37. Contact details</b>
	<b>38. Revision History</b>

**It is essential that these instructions are read and understood before connecting or powering up this controller.**

## Introduction

Designed for LCD monitor and other flat panel display applications, the DT-1920-VGA controller provides easy to use interface controller for:

- TFT (active matrix) LCDs with LVDS interface of 1920x1200, 1920x1080, 1920x480, 1680x1050, 1600x1200, 1400x1050, 1440x900, 1366x768, 1280x1024, 1280x800, 1280x768, 1024x768, 1024x600, 960x960, 800x600, 800x480, 640x480 resolution
- Computer video signals of WUXGA, UXGA, SXGA, XGA, SVGA, VGA standard
- Support VGA input
- Support LVDS interface panel
- Support DDC/CI at VGA port.

### Ordering information :

Controller	Part number	Ordering part number
DT-1920-VGA	P/N 41775000X-3	P/N 4177500XX-3

### HOW TO PROCEED

- Ensure you have all parts & that they are correct, refer to:
  - Connection diagram (separate document for each panel)

#### Controller Solution Generator

Full web resource matching controllers & panels with **connection diagrams** for download.  
See at : <http://www.digitalview.com/csg>

- Connector reference (in following section)
- Assembly notes
- Check controller switch & jumper settings (errors may damage the panel)
- Prepare the PC
- Connect the parts
- Understand the operation and functions (in following section)

### IMPORTANT USAGE NOTE

This product is for use by system developers and integrators, the manufacturer accepts no liability for damage or injury caused by the use of this product. It is the responsibility of the developer, integrators or other user of this product to:

- Ensure that all necessary and appropriate safety measures are taken.
- Obtain suitable regulatory approvals as may be required.
- Check power settings to all component parts before connection.
- Understand the operation and connectivity requirements of this controller.

### DISCLAIMER

There is no implied or expressed warranty regarding this material.

## SYSTEM DESIGN

A typical LCD based display system utilising this controller is likely to comprise the following:

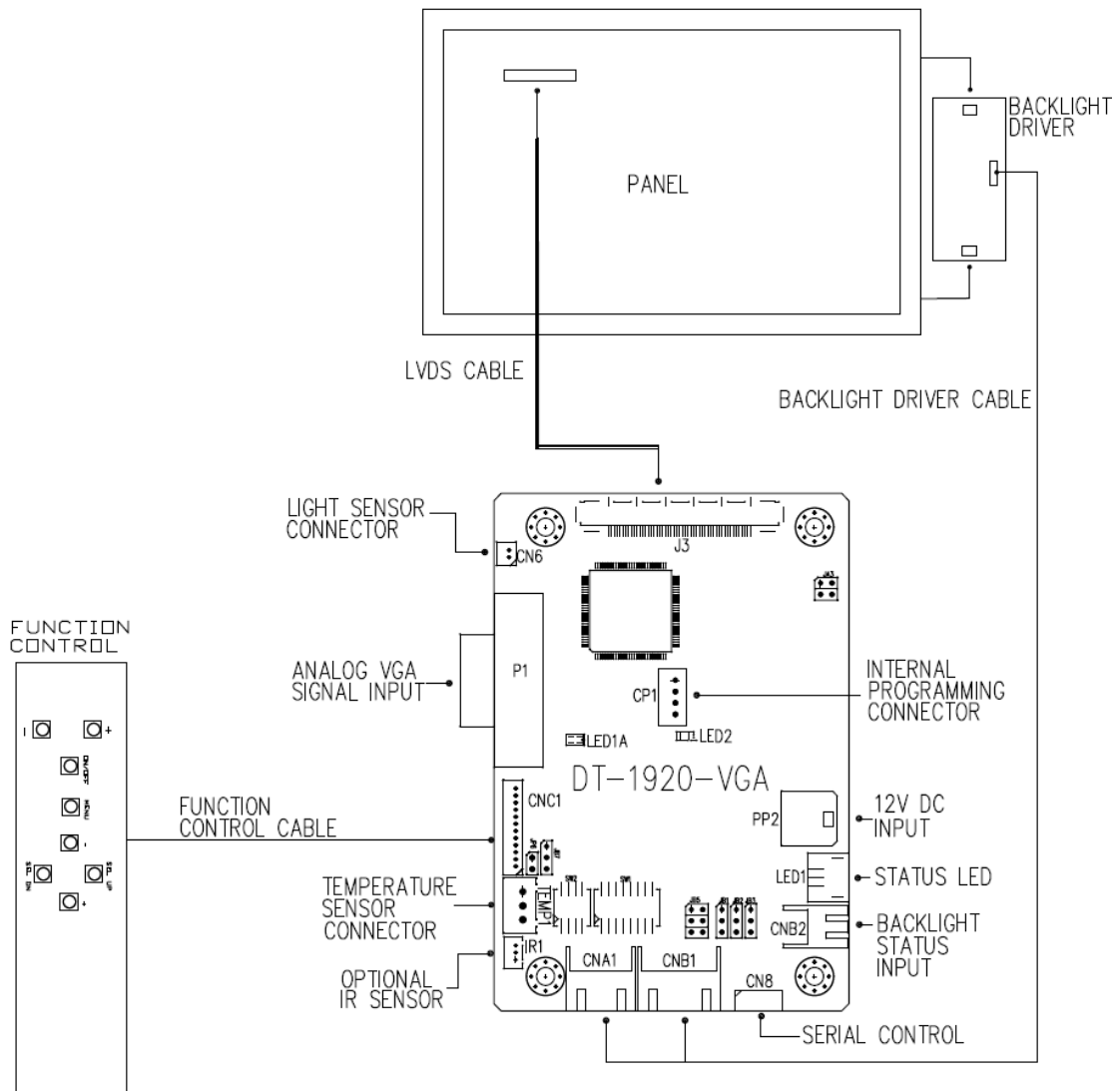

## ASSEMBLY NOTES

This controller is designed for monitor and custom display projects using 1920 x 1200, 1920 x 1080, 1920x480, 1680x1050, 1600x1200, 1400x1050, 1440x900, 1366x768, 1280x1024, 1280x800, 1280x768, 1024x768, 1024x600, 800x600, 800x480, 640x480 resolution TFT panels with a VGA, SVGA, XGA, SXGA, UXGA, WUXGA signal input. The following provides some guidelines for installation and preparation of a finished display solution.

**Preparation:** Before proceeding it is important to familiarize yourself with the parts making up the system and the various connectors, mounting holes and general layout of the controller. As much as possible connectors have been labeled. Guides to connectors and mounting holes are shown in the following relevant sections.

- LCD Panel:** This controller is designed for typical LVDS interface TFT panels with panel voltage 3.3V or 5V or 12V LVDS interface. Due to the variation between manufacturers of signal timing and other panel characteristics factory setup and confirmation should be obtained before connecting to a panel. (**NOTE: Check panel power jumper settings before connection**)
- Controller card:** Handle the controller card with care as static charge may damage electronic components.
- LVDS signal cable :** In order to provide a clean signal it is recommended that LVDS signal cables are no longer than 46cm (18 inches). If loose wire cabling is utilized these can be made into a harness with cable ties. Care should be taken when placing the cables to avoid signal interference. Additionally it may be necessary in some systems to add ferrite cores to the cables to minimize signal noise.
- Backlight Driver:** This will be required for the backlight of an LCD, some LCD panels have an inverter built in. As panels may have 1 or more backlight tubes and the power requirements for different panel models backlights may vary it is important to match the inverter in order to obtain optimum performance. See page 18 for the Application notes Inverter connection section for more informations.
- Backlight Driver Cables:** Different inverter models require different cables and different pin assignment. Make sure correct cable pin out to match the inverter. Using wrong cable pin out may damage the inverter.
- OSD switch mount controls:** The following section discusses the controls required and the section on connectors provides the detail. The controls are minimal: On/Off, Backlight Brightness (depends on inverter), OSD (5 momentary buttons) analog VR type or (8 momentary buttons) digital type.
- OSD switch mount controls cable:** The cables to the function switches should be of suitable quality and length so that impedance does not affect performance. Generally lengths up to 1 metre (3 feet) should be acceptable.
- Controller status LED :** This LED indicates the controller status. The pin direction of the LED should be corrected for right colour indication. The status LED1A and LED2 are built on board. The status LED1 is an optional part only, can be unconnected. Please find below the colour status definition :

Controller LED status (LED1 & LED1A) :

State	LED color
No signal & backlight off	RED
With signal & backlight on	GREEN
Update EDID in progress or Displayport EDID is error	ORANGE

Power LED status (LED2) :

State	LED status
Power input to controller	ON
No power input to controller	OFF

- IR sensor:** It is an optional part only, can be unconnected if not using IR remote control. See Appendix VI for button definition.
- RS-232 control interface :** Firmware upgrade and serial control via this interface port. See Appendix II for the RS-232 serial control protocols.
- Analog VGA Input Cable:** As this may affect regulatory emission test results and the quality of the signal to the controller, a suitably shielded cable should be utilized. This port support DDC/CI (See Appendix III in details).
- Backlight status input :** It only functions when connecting with the panel which support backlight status detection pin.
- Light Sensor :** Support for connection using light sensor cable P/N 426305900-3 (1250mm) and light sensor board P/N 416021310-3 via CN6 connector. See Appendix VII in details.
- Temperature Sensor :** This controller has the on-board temperature sensor which allow to read the temperature on board via RS-232 query command. It can also support for connection with external temperature sensor using temperature sensor cable and temperature sensor board P/N 416021320-3. See Appendix VIII in details.

**17. Power Input:** 12V DC is required, this should be a regulated supply. Although the controller provides power regulation for the LCD power this does not relate to the power supplied to the backlight inverter. If an unregulated power supply is provided to an inverter any fluctuations in power may affect operation, performance and lifetime of the inverter and or backlight tubes.

- **Power Safety:** Note that although only 12VDC is supplied as 'power-in' a backlight inverter for panel backlighting produces significantly higher voltages (the inverter does not connect to the ground plane). We strongly advise appropriate insulation for all circuitry.
- **EMI:** Shielding will be required for passing certain regulatory emissions tests. Also the choice of external Controller to PC signal cable can affect the result.
- **Ground:** The various PCB mounting holes are connected to the ground plane.
- **Servicing:** The board is not user serviceable or repairable. Warranty does not cover user error in connecting up to the controller and is invalidated by unauthorized modification or repairs.
- **Controller Mounting:** It is recommended that a clearance of at least 10mm is provided above and 5mm below the controller when mounted. Additionally consideration should be given to:
  - Electrical insulation.
  - Grounding.
  - EMI shielding.
  - Cable management. Note: It is important to keep panel signal cables apart from the inverter & backlight cables to prevent signal interference.
  - Heat & Ventilation: Heat generated from other sources, for example the backlight of a very high brightness panel may generate significant heat which could adversely affect the controller.
  - Other issues that may affect safety or performance.
- **PC Graphics Output:** A few guidelines:
  - Signal quality is very important, if there is noise or instability in the PC graphics output this may result in visible noise on the display.
  - Refer to graphics modes table in specifications section for supported modes.
  - Non-interlaced & interlaced video input is acceptable.

**IMPORTANT: Please read the Application Notes section for more information.**

## CONNECTION & OPERATION

**CAUTION:** Never connect or disconnect parts of the display system when the system is powered up as this may cause serious damage.

### CONNECTION

Connection and usage is quite straight forward (it is useful to have the relevant connection diagram available at this time):

1. **LCD panel & Inverter:** Connect the inverter (if it is not built-in the panel) to the lead connector of the LCD panel.
2. **LVDS type panels:** Plug the LVDS signal cable direct to J3. Insert the panel end of the cable to the LCD panel connector.
3. **Inverter & Controller:** Plug the inverter cable to CNB1 and CNA1 (if necessary). Plug another end to the connector on the inverter.
4. **Function switch & Controller:** Plug the OSD switch mount cable to CNC1 on the controller board and another to the OSD switch mount.
5. **LED 1 :** Plug in a 3-way with dual colour LED to connector LED1 on the controller board for indicating the controller status.
6. **LED 1A :** On board dual colour LED for indicating the controller status.
7. **LED 2 :** On board single color LED for indicating the input power status.
8. **IR & Controller:** Plug in a 3-way with IR sensor to connector IR1 on the controller board.
9. **Jumpers :** Check all jumpers are set correctly. Details referring the connection diagram at <http://www.digitalview.com/controllers/csg.php>
10. **Jumpers & Inverter & Panel voltage:** Particularly pay attention to the settings of JA3, JB2, JB3. JB2 & JB3 are used for inverter control (read inverter specification and information on the jumper table to define the correct settings). JA3 is used for panel voltage input (read panel specification and information on the jumper table to define the correct settings).
11. **VGA cable :** Plug the VGA cable to the connector P1 on the controller board.
12. **Power supply & Controller:** Plug the DC 12V power in to the connector PP2. You can consider to use DigitalView mating power cable P/N 426013800-3, 160mm. Please read the jumper table in page 11-12 to define the correct settings. Otherwise it may break down the panel.
13. **Power on:** Switch on the controller board and panel by using the OSD switch mount.

**CAUTION:** Never connect or disconnect parts of the display system when the system is powered up as this may cause serious damage.

Controller LED status (LED1 & LED1A) :

State	LED color
No signal & backlight off	RED
With signal & backlight on	GREEN
Update EDID in progress or Displayport EDID is error	ORANGE

Power LED status (LED2) :

State	LED status
Power input to controller	ON
No power input to controller	OFF

General:

- If you are using supplied cables & accessories, ensure they are correct for the model of panel and controller.
- If you are making your own cables & connectors refer carefully to both the panel & inverter specifications and the section in this manual, "Connectors, Pinouts & Jumpers" to ensure the correct pin to pin wiring.

### PC SETTINGS

The controller has been designed to take a very wide range of input signals however to optimize the PC's graphics performance we recommend choosing 60Hz vertical refresh rate – this will not cause screen flicker.

### OPERATION

Once the system has been connected and switched on there are a number of functions available to adjust the display image as summarized in the following sections. The settings chosen will be saved for each mode independently.

**LCD DISPLAY SYSTEM SETTINGS**

NOTE: By way of explanation the following refers to a set of sample buttons that may be obtained as an option. In addition to power on/off and connection for backlight brightness the controller provides an On Screen Display of certain functions which are controlled by 5 momentary type buttons (analog VR type) or 8 momentary type buttons (digital type):

Controls	Analog VR type	Digital type
On/Off – turns controller board power on	VR toggle switch	On/Off button
Brightness – controls backlight brightness	Rotary VR	Brightness +/- buttons
Menu – turns OSD menu On or Off (it will auto time off) (Function with signal input only)	Menu button	Menu button
Menu- Power on/off*	Power ON - Press Menu button Power OFF - Hold Menu button for 3-4 sec	Power ON - Press Menu button Power OFF - Hold Menu button for 3-4 sec
Select – Select function / Confirm (under OSD menu on state)	SEL DN	SEL DN
Move up to select OSD menu function (under OSD menu on state)	SEL UP	SEL UP
+ – increase the setting / moves the selector to the next function (under OSD menu on state)	+	+
- - decrease the setting / moves the selector to the previous function (under OSD menu on state)	-	-
Reset to Factory Defaults	Press and hold SEL DN button, then power on the controller	Press and hold SEL DN button, then power on the controller
Direct access key for Backlight Brightness increase / decrease (under OSD menu off state)	+ / - ##	+ / - ##

Remark : \* The jumper JP6 must be always closed when using the 'Default power' feature.  
## - Support on V1.01.00 firmware or later revision.

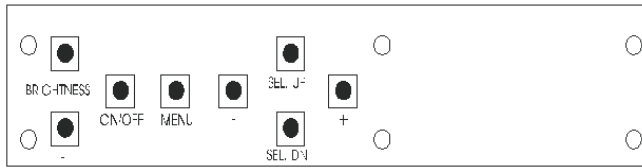

Digital type



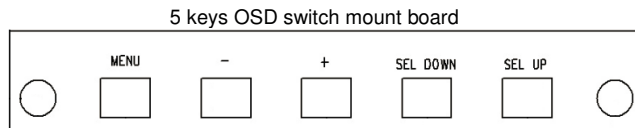





**12V power input :**  
Digital 10K Type OSD switch mount  
P/N 416100520-3 or up

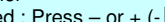
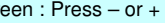
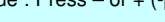

5 keys OSD switch mount board

**12V power input :**  
5 buttons OSD switch mount board P/N 4161003700-3,  
matching cable  
P/N 426123010-3.

OSD Functions

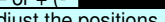
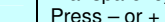
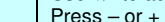
<b>Input Source</b>	
<b>VGA</b>	
<b>Default Power</b>	Off : When the controller detects power in, it will stay in 'Stand-by' mode. On : When the controller detects power in, it will turn on the power and display image. [Default]
<b>Light Sensor</b>	On / Off
<b>Color Settings</b>	
<b>Gamma</b>	1.8 / 2.0 / 2.2 / 2.4 / 2.6 [Default 2.2]
<b>Color Temp.</b>	9300K 7500K 6500K [Default] 5000K 4200K User Color Red : Press – or + (-  +) 0~100 [Default : 100] Green : Press – or + (-  +) 0~100 [Default : 100] Blue : Press – or + (-  +) 0~100 [Default : 100]
<b>Picture Quality</b>	
<b>Black Level</b>	Increase/decrease brightness level. Press – or + (-  +) 0~100 [Default : 50]
<b>Contrast</b>	Increase/decrease contrast level. Press – or + (-  +) 0~100 [Default : 50]
<b>Sharpness</b>	Increase/decrease sharpness level. Press – or + (-  +) 0~100 [Default : 50]
<b>Brightness</b>	Backlight brightness adjustment Press – or + (-  +) 0~100
<b>Invert</b>	Off / On : Invert for the backlight brightness
<b>Control</b>	D/A / PWM : Selection for voltage level dimming control / PWM dimming control
<b>Frequency(Hz)</b>	Backlight frequency 100 ~ 440Hz in a step of 20
<b>Display Settings</b>	
<b>Aspect Ratio</b>	Full : Scaling format to Fill Screen.[Default] 4:3 : Scaling format to 4:3
<b>H.Position</b>	Use +/- to adjust image position horizontally. Press – or + (-  +) 0~100
<b>V.Position</b>	Use +/- to adjust image position vertically. Press – or + (-  +) 0~100
<b>Clock</b>	Adjust the image horizontal size. Press – or + (-  +) 0~100
<b>Phase</b>	Fine tune the data sampling position (adjust image quality) Press – or + (-  +) 0~100
<b>Auto Adjust</b>	Auto adjust the positions, phase, frequency
<b>Auto Color</b>	Auto color calibration [See Appendix V]
<b>Other Settings</b>	
<b>Language</b>	OSD menu language selection : English French German Spanish
<b>OSD Orientation</b>	OSD menu rotation in degree 0 [Default] 90 180 270
<b>OSD Transparency</b>	Transparency : Set OSD transparency Press – or + (-  +) 0~100 [Default : 0]
<b>OSD H.Position</b>	Use +/- to adjust OSD menu position horizontally. Press – or + (-  +) 0~100 [Default : 50]



	<b>OSD V.Position</b>	Use +/- to adjust OSD menu position vertically. Press – or + ( - <input type="text"/> + ) 0~100 [Default : 50]
	<b>OSD Timeout</b>	Timer : OSD Timeout in seconds Press – or + ( - <input type="text"/> + ) 0~60 (ON for Always ON). [Default : 10]
	<b>Factory Reset</b>	Reset : Load factory default settings. Press down on OSD keypad to factory reset
<b>Information</b>		
	Input signal information reported : Resolution / H.Freq / V.Freq	

[Firmware version : V1.00.00 or up]

Items marked ▶ have sub menus.  
Exit the OSD menu to save the setting chosen

## CONNECTORS, PINOUTS & JUMPERS

The various connectors are:

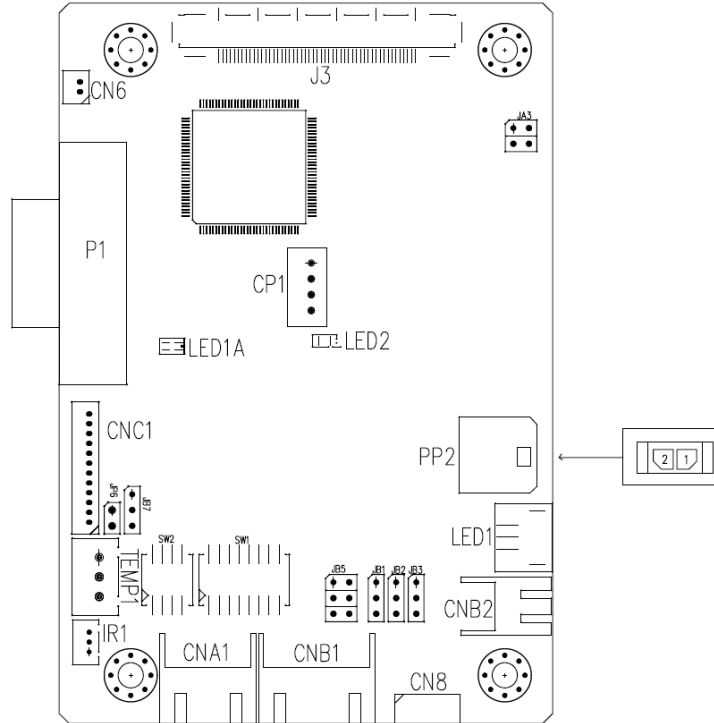

### Summary: Connectors

Ref	Purpose	Description
CN6	Ambient light sensor connector	DF13 2 ways compatible (Matching type : DF13-2S-1.25C)
CN8	Serial control	Molex 53261-0671 compatible, 6 ways 1.25mm pitch (Mating type : Molex 51021-0600) (Matching connection cable P/N 426171800-3)
CNA1	Auxiliary power output	JST 4-way, S4B-XH-A compatible (Mating type : XHP-4) (Matching cable P/N 426040200-3)
CNB1	Backlight inverter	JST 5-way, S5B-XH-A compatible (Mating type : XHP-5) (Matching cable P/N 426058300-3)
CNB2	Backlight status input	JST 2-way, S2B-XH-A compatible (Mating type : XHP-2) (Matching cable P/N 426020800-3)
CNC1	OSD controls	Hirose DF13A-12P-1.25H compatible (Mating type : DF13-12S-1.25C) (Matching OSD switch mount cable P/N 426122200-3 (150mm) or 426122210-3 (250mm))
CP1	Internal Programming connector	JST B4B-PH-K-S compatible (Matching type : PHR-4)
IR1	Infra-Red sensor connector	Molex 53261-0371 compatible, 3 way 1.25mm pitch (Mating type : 51021-0300) (Matching connection cable P/N 426031500-3)
LED1	Dual color LED connector for controller status	JST 3-way, S3B-ZR-SM4A compatible (Mating type : ZHR-3) (Matching connection cable P/N 426031400-3)
J3	LVDS panel signal	JAE FI-RE51S-HF (Mating type : JAE FI-RE51HL)
P1	VGA signal input	DB-15 way high density 3 row
PP2	Power input	Molex 43650-0200 compatible (Mating type : Molex 43645-0200 compatible) (Matching power cable : P/N 426013800-3, 160mm)
TEMP1	Temperature Sensor connector	JST B3B-XH-A compatible (Matching type : XHP-3)

Summary: Jumpers setting

Ref	Purpose	Note
JA3	Panel power voltage select	See panel voltage setting table 1 <b>CAUTION:</b> Incorrect setting will cause panel damage
JB1	Backlight brightness voltage range	1-2 closed = 3.3V max 2-3 closed = 5V max
JB2	Backlight inverter on/off control – signal level	1-2 = On/Off control signal 'High' = +3.3V 2-3 = On/Off control signal 'High' = +5V Open = On/Off control signal 'High' = Open collector <b>CAUTION:</b> Incorrect setting can damage inverter.
JB3	Backlight inverter on/off control – polarity	1-2 = control signal 'high' = Backlight ON 2-3 = control signal 'low' = Backlight ON
JB5	Backlight control type selection	1-2 = VR/Digital switch mount control 3-4 = Analog backlight brightness control via RS-232 command (0xe0) or OSD menu. 5-6 = PWM (Pulse Width Modulation) brightness
JB7	Backlight control voltage on CNB1 pin 4 (Function when JB5 sets 1-2 closed)	Open = For OSD switch mount control (Default) 1-2 = 0V 2-3 = 3.3V / 5V controlled by JB1
JP6	Input power control	Short = External switch control Open = Switch mount control
SW1	Panel selection	See table below
SW2	Panel selection	See table below

**Table 1 : Panel voltage setting table :**

Input voltage via PP2	Panel Voltage	JA3	Jumper on board
12VDC	3.3V	3V3	JA3 5V <input type="checkbox"/> <input type="checkbox"/> 3V3 <input checked="" type="checkbox"/>
	5V	5V	JA3 5V <input checked="" type="checkbox"/> 3V3 <input type="checkbox"/> <input type="checkbox"/>
	12V	OPEN	JA3 5V <input type="checkbox"/> <input type="checkbox"/> 3V3 <input type="checkbox"/> <input type="checkbox"/>

**CAUTION: Incorrect setting can damage panel & controller**

JA3 location on board : (Please pay attention to the jumper settings on JA3 which are red in color on board)

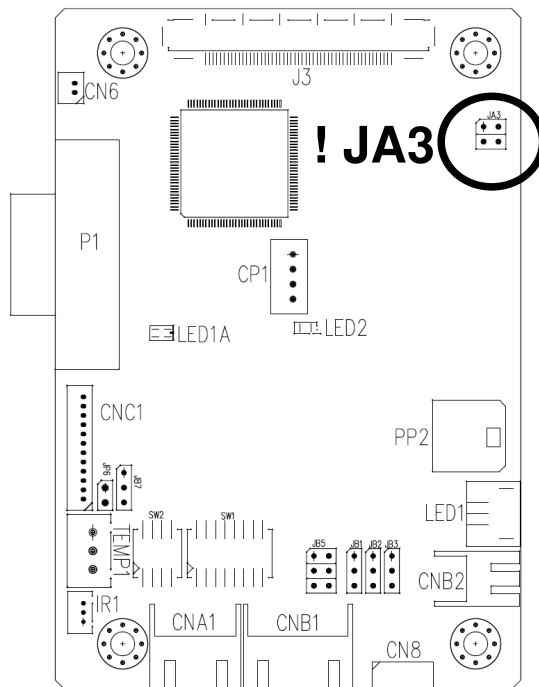

**DIP Switch selection – SW1**

Pos #1	Pos #2	Pos #3	Pos.#4	Description	Panel resolution
<b>For WUXGA panel</b>					
OFF	OFF	OFF	OFF	Samsung LTM230HT10 (Tested) AUO T215HVN01.0 (Tested)	1920x1080 1920x1080
ON	OFF	OFF	OFF	Samsung LTM220CS01 (Tested) KOE TX26D202VM0BAA <sup>##</sup>	1920x1200 1920x1200
OFF	OFF	ON	OFF	AUO G173HW01 (Tested) KOE TX18D200VM0EAA (Tested)	1920x1080 1920x1080
<b>For UXGA panel</b>					
ON	OFF	OFF	OFF	NEC NL160120BC27-32B	1600x1200
<b>For WXGA panel</b>					
ON	OFF	OFF	OFF	AUO G156XW01.V10	1366x768
OFF	ON	ON	OFF	AUO B101EW05 V0	1280x800
ON	OFF	ON	ON	NEC NL12876BC26-25 <sup>##</sup>	1280x768
<b>For SXGA panels</b>					
ON	OFF	OFF	ON	HannStar HSD170ME13-A06	1280x1024
<b>For XGA panel</b>					
OFF	OFF	ON	ON	AUO M150XN07 V2 (Tested)	1024x768
ON	OFF	OFF	ON	NEC NL10276BC24-21F <sup>##</sup>	1024x768
OFF	ON	OFF	ON	NEC NL10276BC20-04 <sup>##</sup>	1024x768
<b>SVGA</b>					
OFF	OFF	ON	OFF	NEC NL8060BC26-35F	800x600
<b>VGA/WVGA</b>					
OFF	ON	OFF	OFF	Mitsubishi AA104VJ02	640x480
OFF	ON	OFF	ON	NEC NL8048BC19-02	800x480
ON	OFF	OFF	ON	KOE TX20D208VM0BAA <sup>##</sup>	800x480
<b>Others</b>					
OFF	OFF	ON	ON	HannStar HSD190MGW1-A00	1440x900

For additional and recent added panels, see DT-1920-VGA panel support table at <http://www.digitalview.com/controllers/csg.php>

Remark :

<sup>##</sup> - Support on V1.01.00 firmware or later revision.

Pos #5	Pos #6	Pos #7	Description
OFF	OFF	OFF	WUXGA
ON	OFF	OFF	UXGA
OFF	ON	OFF	SXGA
ON	ON	OFF	WXGA
OFF	OFF	ON	XGA
ON	OFF	ON	SVGA
OFF	ON	ON	VGA / WVGA
ON	ON	ON	Others

SW1 Pos 8 = Reserved.

**DIP switch selection – SW2**

Pos. #	Function	Description
1	Panel pixel format	OFF : Double Pixel ON : Single Pixel
2	LVDS data mapping select	ON : Mapping A (LVDS panel) OFF : Mapping B (LVDS panel) Please adjust to get the correct picture. See as Appendix IV for details of mapping A and B.
3	Reserved	Reserved
4	Reserved	Reserved

The most current list can be found the controller solution generator at <http://www.digitalview.com/controllers/csg.php>

**CN6 – Ambient light sensor connector : DF13 2 ways compatible (Matching type : DF13-2S-1.25C)**

PIN	SYMBOL	DESCRIPTION
1	3.3V	3.3V
2	ALS	Ambient light sensing

**CN8 – RS-232 serial control: Molex 53261-0671, 6 ways 1.25mm pitch (Matching type : Molex 51021-0600)**

PIN	SYMBOL	DESCRIPTION
1	SDATA	Reserved
2	SCLK	Reserved
3	VCC	+5V
4	TXD	RS-232 Tx data
5	GND	Ground
6	RXD	RS-232 Rx data

**CNA1 - Auxiliary power output: JST S4B-XH-A (Matching type : XHP-4)**

PIN	SYMBOL	DESCRIPTION
1	AUX POWER	+12V DC, 500mA max
2	GND	Ground
3	GND	Ground
4	AUX 5V	+5V DC, 500mA max

**CNB1 – Backlight inverter connector: JST S5B-XH-A (Matching type : XHP-5)**

PIN	SYMBOL	DESCRIPTION
1	GND	Ground
2	VBKL	Backlight power supply, +12VDC DC, 3A max
3	BLCTRL	Backlight On/Off control signal (refer to JB2 & JB3)
4	BVR_WIP	Backlight brightness VR pin WIP
5	BVR_A	Backlight brightness VR pin A

**CNB2 – Backlight status connector : JST B2B-XH-A (Matching type : XHP-2)**

PIN	SYMBOL	DESCRIPTION
1	BL_S	Backlight status signal
2	GND	Ground

**CNC1 – OSD switch mount control, Hirose DF13A-12P-1.25H (Mating type : DF13-12S-1.25C)**

PIN	SYMBOL	DESCRIPTION
1	PSWIN	Power button A
2	SW_ON	Power button B
3	BVR_A	Backlight Brightness VR pin A
4	BVR_WIP	Backlight Brightness R pin WIP
5	BVR_B	Backlight Brightness VR pin B (470 ohm resistor to +5V Vcc)
6	GND	Ground
7	MENU	OSD menu
8	-/LEFT	OSD -/Left
9	+/RIGHT	OSD +/Right
10	SEL_DN	OSD Select down
11	SEL_UP	OSD Select up
12	POWER KEY	OSD POWER KEY

**IR1 – Infra-Red sensor connector: Molex 53261-0371, 3 way 1.25mm pitch (Matching type : Molex 51021-0300)**

PIN	SYMBOL	DESCRIPTION
1	GND	Ground
2	STDBY_Vcc	Stand by voltage
3	IR Data	IR data

**J3 – LVDS output connector: JAE FI-RE51S-HF (Matching type : JAE FI-RE51HL)**

PIN	SYMBOL	DESCRIPTION
1	VDD (+12V)	Panel power supply (+12V) (selected by JA3)
2	VDD (+12V)	Panel power supply (+12V) (selected by JA3)
3	VDD (+12V)	Panel power supply (+12V) (selected by JA3)
4	VDD (+12V)	Panel power supply (+12V) (selected by JA3)
5	VDD (+12V)	Panel power supply (+12V) (selected by JA3)
6	VDD (3,3V/5V)	Panel power supply (3,3V/5V) (selected by JA3)
7	VDD (3,3V/5V)	Panel power supply (3,3V/5V) (selected by JA3)
8	VDD (3,3V/5V)	Panel power supply (3,3V/5V) (selected by JA3)
9	VDD (3,3V/5V)	Panel power supply (3,3V/5V) (selected by JA3)
10	VDD (3,3V/5V)	Panel power supply (3,3V/5V) (selected by JA3)
11	GND	Ground
12	GND	Ground
13	GND	Ground
14	GND	Ground
15	GND	Ground
16	OP1	3.3V enable controlled by JP2
17	OP2	3.3V enable controlled by JP3
18	OP3	3.3V enable controlled by JP4
19	OP4	3.3V enable controlled by JP5
20	GND	Ground
21	GND	Ground
22	NC	No connection
23	NC	No connection
24	TXA3+	Positive differential LVDS data bit A3
25	TXA3-	Negative differential LVDS data bit A3
26	GND	Ground
27	TXAC+	Positive LVDS clock for A channel
28	TXAC-	Negative LVDS clock for A channel
29	GND	Ground
30	TXA2+	Positive differential LVDS data bit A2
31	TXA2-	Negative differential LVDS data bit A2
32	TXA1+	Positive differential LVDS data bit A1
33	TXA1-	Negative differential LVDS data bit A1
34	TXA0+	Positive differential LVDS data bit A0
35	TXA0-	Negative differential LVDS data bit A0
36	GND	Ground
37	NC	No connection
38	NC	No connection
39	TXB3+	Positive differential LVDS data bit B3
40	TXB3-	Negative differential LVDS data bit B3
41	GND	Ground
42	TXBC+	Positive LVDS clock for B channel
43	TXBC-	Negative LVDS clock for B channel
44	GND	Ground
45	TXB2+	Positive differential LVDS data bit B2
46	TXB2-	Negative differential LVDS data bit B2
47	TXB1+	Positive differential LVDS data bit B1
48	TXB1-	Negative differential LVDS data bit B1
49	TXB0+	Positive differential LVDS data bit B0
50	TXB0-	Negative differential LVDS data bit B0
51	GND	Ground

**LED1 – Dual color LED connector for controller status, JST 3-way, S3B-ZR-SM4A (Mating type : JST ZHR-3)**

PIN	DESCRIPTION
1	Green LED pin (anode)
2	LED pin common (cathode)
3	Red LED pin (anode)

**P1 - Analog VGA input – DB-15 way high density 3 row**

PIN	SYMBOL	DESCRIPTION
1	PCR	Red, analog
2	PCG	Green, analog
3	PCB	Blue analog
4	ID2	Reserved for monitor ID bit 2 (grounded)
5	DGND	Digital ground
6	AGND	Analog ground red
7	AGND	Analog ground green
8	AGND	Analog ground blue
9	DDC_5V	+5V power supply for DDC (optional)
10	DGND	Digital ground
11	ID0	Reserved for monitor ID bit 0 (grounded)
12	DDC_SDA	DDC serial data
13	HS_IN	Horizontal sync or composite sync, input
14	VS_IN	Vertical sync, input
15	DDC_SCL	DDC serial clock

**PP2 - Power supply****(Mating type : Molex 43645-0200 compatible)**

PIN	DESCRIPTION
1	+12VDC 5A max
2	Ground

**TEMP1 - Temperature Sensor Connector : JST B3B-XH-A****(Matching type : XHP-3)**

PIN	SYMBOL	DESCRIPTION
1	GND	Ground
2	VDD	3.3V
3	EXT_TMP_SENSOR	Temperature sensor input



## CONTROLLER DIMENSIONS

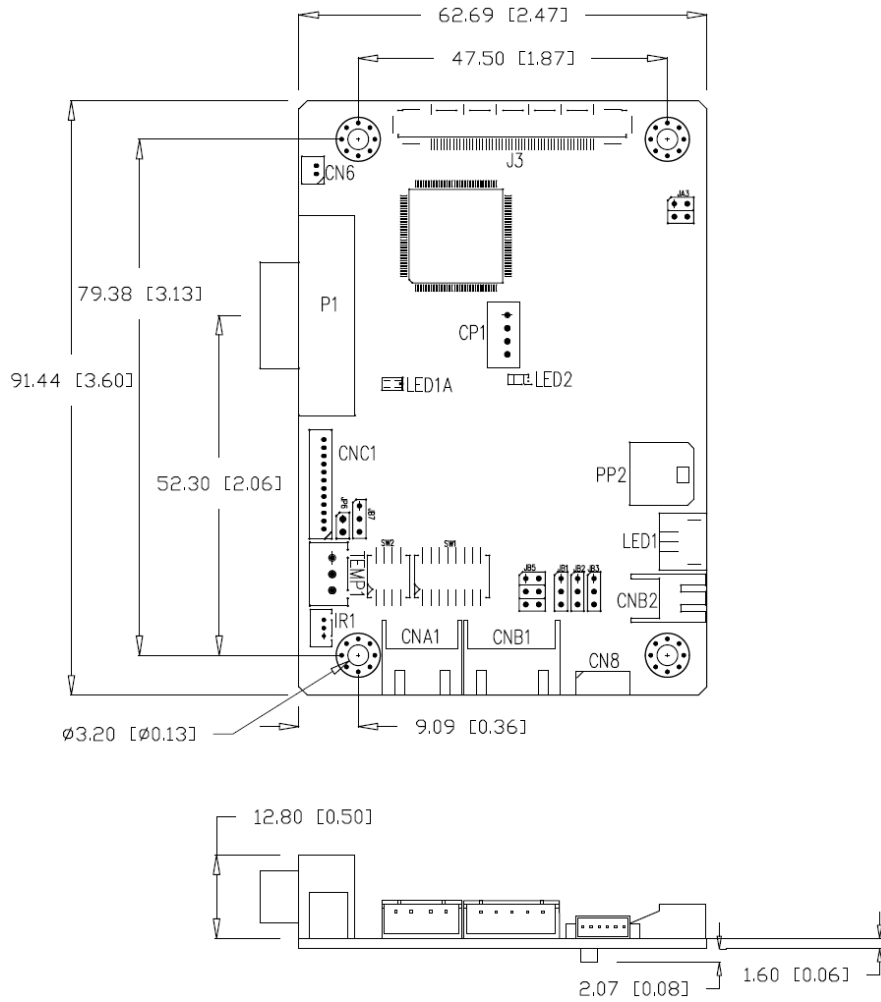

The maximum thickness of the controller is 16.5mm (measured from bottom of PCB to top of components, including any underside components & leads). We recommend clearances of:

- 5mm from bottom of PCB - if mounting on a metal plate we also recommend a layer of suitable insulation material is added to the mounting plate surface.
- 10mm above the components
- 3~5mm around the edges

Any of the holes shown above can be used for mounting the PCB, they are 3.2mm in diameter.

**CAUTION: Ensure adequate insulation is provided for all areas of the PCB with special attention to high voltage parts such as the inverter.**

## APPLICATION NOTES

### USING THE CONTROLLER WITHOUT BUTTONS ATTACHED

This is very straightforward by following the steps below :

- Firstly setup the controller/display system with the buttons. With controls attached and display system active make any settings for colour and image position as required then switch everything off.
- Use a jumper to close JP6 jumper, this will fix the board On.
- Refer to inverter specifications for details as to fixing brightness to a desired level, this may require a resistor, an open circuit or closed circuit depending on inverter.

### INVERTER CONNECTION

There are potentially 3 issues to consider with inverter connection:

- Power
- Enable
- Brightness

Please read the following sections for a guide to these issues.

**Inverter Power:** As per the table for CNB1 pin 1 is ground and pin 2 provides DC12V/ 24V DC . This should be matched with the inverter specification: see table.

CNB1	
PIN	DESCRIPTION
1	Ground
2	+12VDC

Remark: For higher power inverter, more current (for 12V) can be taken from CNA1 pin 1. Maximum current drawn on CNA1 pin 1 and CNB1 pin 2 is 3A(12V)

**Enable:** This is a pin provided on some inverters for On/Off function and is used by this panel controller for VESA DPMS compliance. If the inverter does not have an enable pin or the enable pin is not used then DPMS will not be operational. Pin 3 should be matched to the inverters specification for the 'enable' or 'disable' pin.

CNB1	
PIN	DESCRIPTION
3	Enable

Further, jumpers JB2 & JB3 should be set to match the inverters specification for the enable pin power and High or Low setting: see table.

Ref	Purpose	Note
JB2	Inverter enable voltage	1-2 H = 3.3V, 2-3 H = 5V (Vcc), OPEN H = open collector
JB3	Inverter control	1-2 H = On, 2-3 L = On

**Brightness:** There are various methods for brightness control and it is important to consider the specifications for the inverter to be used. Generally the situation is:

- Brightness can controlled by using a resistor or VR (Variable Resistor).
- Brightness controlled by adding a circuit such as PWM (Pulse Width Modulation).
- No adjustment of brightness is possible.

CNB1 pins 4 & 5 are available for connecting to an inverter or circuit where VR control is supported.

CNB1	
PIN	DESCRIPTION
4	VR WIP
5	VR A

This can then be matched with function controls (OSD switch mount) pins 3 & 4: see cable design below .

## Design Guideline for making VR circuitry :

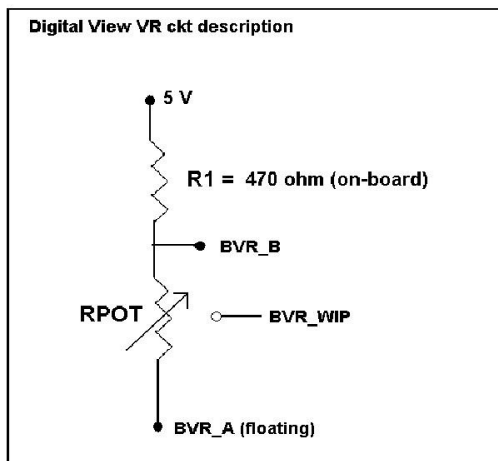

### Signal description / Notes :

- 1) R1 : 470ohm on board
- 2) RPOT is an external potentiometer (in-line dip style) that can be plugged directly into CNC1 pins 3,4,5. RPOT must be supplied / installed by user.
- 3) BVR\_B : Voltage tapped from “top” of potentiometer, the node of R1 and RPOT.
- 4) BVR\_WIP : Voltage tapped from wiper arm of RPOT.
- 5) BVR\_A : Voltage tapped from “bottom” of RPOT.

**Note : BVR\_A voltage is left floating on the controller board. To use this circuit, you need to tie this point to a potential (usually GND, available at CNC1 pin 6).**

### CNB1 – Backlight inverter connector: JST B5B-XH-A (Matching type : XHP-5)

PIN	SYMBOL	DESCRIPTION
1	GND	Ground
2	VBKL	+12VDC, backlight power supply (selected by JA3)
3	BLCTRL	On/Off control (enable) – see JB2 & JB3
4	BVR_WIP	Brightness VR - WIP
5	BVR_A	Brightness VR A

### CNC1 – Control switch, JST B12B-XH-A (Matching type : XHP-12)

PIN	SYMBOL	DESCRIPTION
1	PSWIN	Power button A
2	SW_ON	Power button B
3	BVR_A	Backlight Brightness VR pin A
4	BVR_WIP	Backlight Brightness R pin WIP
5	BVR_B	Backlight Brightness VR pin B (470 ohm resistor to +5V Vcc)
6	GND	Ground
7	MENU	OSD menu
8	-/LEFT	OSD -/Left
9	+ /RIGHT	OSD +/Right
10	SEL_DN	OSD Select down
11	SEL_UP	OSD Select up
12	NC	No connection

The VR for brightness depends on the inverter. The main power load for On/Off is handled by a relay on the controller.

### Example for circuit design :

- 1.) Choose RPOT = 10K
- 2.) Tie BVR\_A to GND
- 3.) Circuit analysis gives BVR\_WIP as the following (see Figure 1)

$$BVR\_WIP = 5 \times (Rbc/10.47)$$

where BVR\_WIP is in Volts.  
And Rbc is the resistance from the wiper arm to bottom of pot in Kohms.

To evaluate, plug in different values of Rbc :

Rbc	BVR_WIP
0	0 V
2.5 K	1.2 V
5 K	2.4 V
7.5 K	3.6 V
10 K	4.8 V

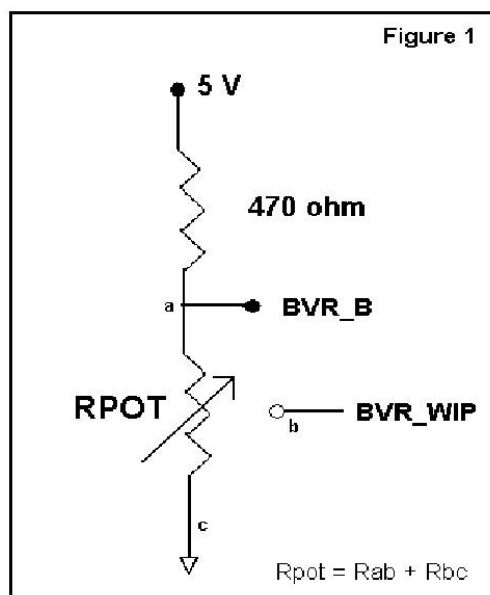

---

## TROUBLESHOOTING

### General

A general guide to troubleshooting a flat panel display system it is worth considering the system as separate elements, such as:

- Controller (jumpers, PC settings)
- Panel (controller, cabling, connection, panel, PC settings)
- Backlight (inverter, cabling, backlight tubes)
- Cabling
- Computer system (display settings, operating system)

Through step by step cross checking with instruction manuals and a process of elimination to isolate the problem it is usually possible to clearly identify the problem area.

### No image:

- If the panel backlight is not working it may still be possible to just see some image on the display.
- A lack of image is most likely to be caused by incorrect connection, lack of power, failure to provide a signal or incorrect graphic card settings.

### Image appearance:

- A faulty panel can have blank lines, failed sections, flickering or flashing display
- Incorrect graphics card refresh rate, resolution or interlaced mode will probably cause the image to be the wrong size, to scroll, flicker badly or possibly even no image.
- Incorrect jumper settings on the controller may cause everything from total failure to incorrect image. CAUTION: Do not set the panel power input incorrectly.
- Sparkling on the display: faulty panel signal cable.

### Backlight:

Items to check include: Power input, Controls, Inverter and Tubes generally in this order.

If half the screen is dimmer than the other half:

- Check cabling for the inverter.
- For a specific backlight tube check the AC pins orientation (CAUTION: Never reverse any DC power pins).

Also:

- If adjusting brightness control has no effect the chances are that the VR rating or method of adjusting brightness is not compatible or correctly connected to the inverter.
- If system does not power down when there is a loss of signal

### Continued failure:

If unit after unit keeps failing consider and investigate whether you are short circuiting the equipment or doing something else seriously wrong.

Generally after common sense issues have been resolved we recommend step by step substitution of known working parts to isolate the problem.

## SPECIFICATIONS

Panel compatibility	1920x1200, 1920x1080, 1920x480, 1680x1050, 1600x1200, 1400x1050, 1440x900, 1366x768, 1280x1024, 1280x800, 1280x768, 1024x768, 1024x600, 960x960, 800x600, 800x480, 640x480 resolution TFT LVDS LCD's support.
No. of colours	Up to 3 x 8 bit providing 16.7 million colours.
Vertical refresh rate	WUXGA, UXGA, WXGA, SXGA, XGA, SVGA, VGA resolution up to 60Hz.
Dot clock (pixel clock) maximum	165 MHz
Graphics formats	Standard WUXGA, UXGA, SXGA, XGA, SVGA, VGA
Standard input at source	- VGA analog (15-pin) standard with automatic detection of : Digital Separate Sync Sync-On-Green
Controls available	- On/Off - Brightness (inverter) - OSD menu - OSD select - OSD setting + - OSD setting -
Control interface	- Buttons, RS-232, IR remote control, DDC/CI.
Settings memory	Settings are stored in non volatile memory
Language OSD support	English OSD texts
VESA DPMS implementation	Yes
Plug & Play	VESA DDC 1, 2/b compatible
Voltage output for LCD	+3.3V , +5V, +12V The current drawn for 3.3V, 5V or 12V panel from 12VDC power input is limited to 3A.
Input voltage	12VDC , 5A max +/- 5%
Controller power consumption	Approx 2.5W (controller logic only, no panel and inverter are involved)
Controller dimensions	62.7mm x 91.4mm x 16.5mm
Storage temperature limits	-40°C to +70°C
Operating temperature limits	0°C to +60°C
Use of memory on board	- 1 pc MCU in TSUMP88CMT9-1 on U2 2Mbits which is a volatile memory for SRAM for OSD storage. - 1 pc Flash memory on U6 8Mbits which is a non-volatile memory for system program. - 1 pc EEPROM on U14 2Kbits which is a non-volatile memory for VGA EDID storage. - 1 pc EEPROM on U9 128Kbits which is a non-volatile memory for system settings.

### NOTES

Please note the following:

- For specific panel setup a sample of an LCD may be required (this will be returned) and a copy of the full technical specifications for the panel from the manufacturer.
- Layout and custom development services are available.

## Appendix I – Mode Support Table

### VGA (P1) port :

Mode	Resolution	Sync Mode
V_60	640x480 60Hz	Digital Separate Sync
SV_60	800x600 60Hz	Digital Separate Sync
SV_60	800x600 60Hz	Sync On Green
X_60	1024x768 60Hz	Digital Separate Sync
X_60	1024x768 60Hz	Sync On Green
WXGA_60	1280x768 60Hz	Digital Separate Sync
WXGA_60	1280x768 60Hz	Sync On Green
WXGA_60	1280x800 60Hz	Digital Separate Sync
WXGA_60	1280x800 60Hz	Sync On Green
WXGA_60	1366x768 60Hz	Digital Separate Sync
WXGA_60	1366x768 60Hz	Sync On Green
WXGA+_60	1440x900 60Hz	Digital Separate Sync
WXGA+_60	1440x900 60Hz	Sync On Green
SX_60	1280x1024 60Hz	Digital Separate Sync
SX_60	1280x1024 60Hz	Sync On Green
UX_60	1600x1200 60Hz	Digital Separate Sync
UX_60	1600x1200 60Hz	Sync On Green
WUX_60	1920x1080 60Hz	Digital Separate Sync
WUX_60	1920x1200 60Hz	Digital Separate Sync

## Appendix II – RS-232 control protocols

### RS-232 Serial control (Baud rate 9600, 8 bits, 1 stop bit and no parity)

Physical connection :

Controller side  
Connector interface : CN8  
Mating connector : Molex 51021-0600

Computer side  
Connector interface : Serial port  
Mating connector : DB9 Female



PIN#	Description
4	RS-232 Tx Data
5	Ground
6	RS-232 Rx Data

PIN#	Description
2	RS-232 Rx Data
3	RS-232 Tx Data
5	Ground

Software connection :

- The OSD function can be controlled through sending the RS-232 protocol.
- Some commands write to memory that typically has a 1,000,000 write cycles and therefore should not be set to write too frequently or it will shorten the operating life of the controller board.
- The RS-232 program can be custom-made to fit for application or it can be used the program provided by Digitalview on request. Please contact your local sales for information.

#### 1. Commands to implement switch mount control buttons

Function	Command	Description	Acknowledge (if enabled)
Menu	0xf7	Menu button pressed	Button equivalent
Select-down button	0xfa	Select down button pressed	Button equivalent
Select-up button	0xfb	Select up button pressed	Button equivalent
Right/+ button	0xfc	Right/+button pressed	Button equivalent
Left/- button	0xfd	Left/- button pressed	Button equivalent

#### 2. Parameter setting - immediate, relative, reset and query

Function	Command	Description	Acknowledge (if enabled)
Brightness control	0x81, nn   "+"   "-"   * "r"   "R"   * "?"	Set brightness = value/increment/decrement Reset Query	Brightness.  Range: "0"0"-6"4" Default: "3"2"
Contrast control	0x82, "a"   "A", nn   "+"   "-"   * "r"   "R"   * "?"	Set all contrast = value/increment/decrement Reset Query	Contrast.  Range: "4"0"-6"4" Default: "3"2"
Saturation control <sup>##</sup>	0x83, nn   "+"   "-"   "r"   "R"   "?"	Set color = value/increment/decrement Reset Query	Range : "0"0"-6"4" Default : "3"2"
Hue control <sup>##</sup>	0x84, nn   "+"   "-"   "r"   "R"   "?"	Set tint = value/increment/decrement Reset Query	Range: "0"0"-6"4" Default: "3"2"
Phase	0x85, nn   "+"   "-"   "?"	Set dot clock phase = value/increment/decrement Query	Dot clock phase.
Image H position	0x86, nn   "+"   "-"   "?"	Set img_hpos = value/increment/decrement Query	Image horizontal position.
Image V position	0x87, nn   "+"   "-"   "?"	Set img_vpos = value/increment/decrement Query	Image vertical position.
Sharpness	0x8a, nn   "+"   "-"   "r"   * "R"   *	Set sharpness= value/increment/decrement Reset	Sharpness  Range: "6"4"-0"0"

Specifications subject to change without notice

© Digital View Ltd – Doc Ver 2.0: 17 Jan 2023

Page 23 of 38

	"?"	Query	Default: "3"2"
Frequency	0x8b, nn   "+"   "-"   "?"	Frequency = value/increment/decrement Query	Frequency adjustment
Scaling Mode	0x8c, n   * "r"   "R"   * "?"	Set graphic image scaling mode = value Reset Query	Image expansion on/off. "0x31" – Full (Fill Screen) "0x39" – 4:3
OSD Rotation	0x8f, "0"   "1"   "2"   "3"   * "r"   "R"   * "?"	Set OSD rotate= 0/90/180/270 Reset Query	OSD rotation Query: "0" – 0 (Default) "1" – 90 "2" – 180 "3" – 270
OSD H position	0x90, nnn   "+"   "-"   "r"   * "R"   * "?"	Set osd_hpos = value/increment/decrement Reset Query	OSD horizontal position  Range: "0"0"0"-"0"6"4" Default: "0"3"2"
OSD V position	0x91, nnn   "+"   "-"   "r"   * "R"   * "?"	Set osd_vpos = value/increment/decrement Reset Query	OSD vertical position  Range: "0"0"0"-"0"6"4" Default: "0"3"2"
OSD Transparency	0x92, n * "r"   "R"   * "?"	Set OSD transparency = value/increment/decrement Reset Query	OSD transparency.  "0x30" – 0 (Default) "0x31" – 20 "0x32" – 40 "0x33" – 60 "0x34" – 80 "0x35" – 100
Select menu timeout	0x93, nn   "+"   "-"   "r"   * "R"   * "?"	Select menu timeout = value/increment/decrement Reset Query	OSD menu timeout value. Value If value > max available step, set it to the max available step. Range: "0"5"-"3"C" Always on : "0"0" Default: "0"A"
Select OSD language	0x95, n   * "r"   "R"   * "?"	Select language = English, Chinese,... Reset Query	"0" – English. "2" - French "3" – Spanish "6" - German
GAMMA value select	0x9d, n   * "r"   "R"   * "?"	Select GAMMA value = Value Reset Query	GAMMA value: "5" – 1.8 "7" – 2.0 "2" – 2.2 (Default) "A" – 2.4 "C" – 2.6
Colour temperature select	0xb3, n   * "r"   "R"   * "?"	Select colour temperature = value Reset Query	Main selected. "0" – user defined RGB values. "1" – 4200K. "2" – 5000K. "3" – 6500K. (Default) "4" – 7500K. "5" – 9300K.
Red level for selected colour temperature	0xb4, nn   "+"   "-"   * "r"   "R"   * "?"	Set the level of the red channel for the selected colour temp. = value/increment/decrement Reset Query	Red level for selected colour temperature.  Range: "0"0"-"6"4" Default: "6"4"



Green level for selected colour temperature	0xb5, nn   "+"   "-"  * "r"   "R"  * "?"	Set the level of the green channel for the selected colour temp. = value/increment/decrement Reset Query	Green level for selected colour temperature.  Range: "0"0"-6"4" Default: "6"4"
Blue level for selected colour temperature	0xb6, nn   "+"   "-"  * "r"   "R"  * "?"	Set the level of the blue channel for the selected colour temp. = value/increment/decrement Reset Query	Blue level for selected colour temperature.  Range: "0"0"-6"4" Default: "6"4"
OSD status enquiry	0xbb	Status of OSD	"0" – OSD turned off "1" – OSD turned on
Backlight brightness control	0xe0, nn   "+"   "-"  * "r"   "R"  * "?"	Set backlight brightness = value/increment/decrement Reset Query	Backlight brightness.  Range: "0"0"-6"4" Default: "6"4"  e.g "1"0" → 0xe0 0x31 0x30 * This control can only function when JB5 sets 3-4 closed  * Apply for inverter control voltage in range of 0~5V. Each step interval is in 1
Backlight on/off control	0xe1, "0"  * "1"  * "r"   "R"  * "?"	Set backlight brightness = Disable backlight Enable backlight Reset Query	Backlight on/off.
Backlight PWM	0xe5, "0"   "1"  * "r"   "R"  * "?"	Set backlight type D/A or PWM Reset Query	"1" – PWM "0" – D/A
Backlight PWM Frequency	0xe6, nnn   "+"   "-"  * "r"   "R"  * "?"	Set Backlight PWM Frequency = Value/ increment/ decrement Reset Query	+/- 20Hz Value 100Hz : "0", "6", "4" 120Hz : "0", "7", "8" 140Hz : "0", "8", "C" 160Hz : "0", "A", "0" 180Hz : "0", "B", "4" 200Hz : "0", "C", "8" 220Hz : "0", "D", "C" 240Hz : "0", "F", "0" 260Hz : "1", "0", "4" 280Hz : "1", "1", "8" 300Hz : "1", "2", "C" 320Hz : "1", "4", "0" 340Hz : "1", "5", "4" 360Hz : "1", "6", "8" 380Hz : "1", "7", "C" 400Hz : "1", "9", "0" 420Hz : "1", "A", "4" 440Hz : "1", "B", "8"
Backlight Invert	0xe7, 0"   "1"  * "?"	Set backlight invert Normal or Invert Query	"1" – Invert "0" – Normal
Query Light Sensor value	0xee,0x70,0x50, 0x35 0x33,0x3F	Query value	e.g. 1735.7→ 0x36 0x43 0x37 0x2E 0x37 )
Query on board temperature	0xee,0x70,0x50, 0x3B 0x34,0x3F	Query value	e.g. +25.6 → 0x2B 0x30 0x31 0x39 0x2E 0x36 )

sensor value			
Query External Temp. Sensor value	0xee,0x70,0x50,0x3B 0x35,0x3F	Query value	e.g. -25.6 → 0x2D 0x30 0x31 0x39 0x2E 0x36 )
Light Sensor Settings <sup>#</sup>	0xee,0x78  "0x30", "n"   "0x31", "nnn"   "0x32", "nnn"   "0x33", "nnn"   "0x34", "nnn"   "0x35", "nnn"   "0x36", "nnn"   "0x37", "nnn"   "0x38", "nnn"   "0x39", "nnn"   "0x3A", "nnn"   "0x3B", "nnn"   "0x3C", "nnn"   "0x3D", "nnn"   "0x3E", "nnn"   "0x3F", "nnn"   "0x40", "nnn"   "0x41", "nnn"   "0x42", "nnn"   "0x43", "nnn"   "0x44", "nnn"   "0x45", "nnn"   "0x46", "nnn"   "0x47", "nnn"   "0x48", "nnn"   0x3F"    "0x57"   *	Light Sensor Settings  0x30 = Light Sensor Mode 0x31 = Level 1 value 0x32 = Level 2 value 0x33 = Level 3 value 0x34 = Level 4 value 0x35 = Level 5 value 0x36 = Level 6 value 0x37 = Level 7 value 0x38 = Level 8 value 0x39 = Level 9 value 0x3A = Level 10 value 0x3B = Level 11 value 0x3C = Level 12 value 0x3D = Backlight 1 value 0x3E = Backlight 2 value 0x3F = Backlight 3 value 0x40 = Backlight 4 value 0x41 = Backlight 5 value 0x42 = Backlight 6 value 0x43 = Backlight 7 value 0x44 = Backlight 8 value 0x45 = Backlight 9 value 0x46 = Backlight 10 value 0x47 = Backlight 11 value 0x48 = Backlight 12 value  Query  Write all light sensor parameters from SRAM into EEPROM	n = "0x30" : Disable, "0x31" : Enable, nnn = 0 ~ 1800 : 0x30,0x30,0x30 ~ 0x37,0x30,0x38  nnn = 0 ~ 100 : 0x30,0x30,0x30 ~ 0x30,0x36,0x34  Or nnn = 0 ~ 255 : 0x30,0x30,0x30 ~ 0x30,0x46,0x46  nnn = OFF: 0x45,0x45,0x45  "0x31": Success "0x30": Fail

### 3. Other control

Function	Command	Description	Acknowledge (if enabled)
Select RS-232 acknowledge	0xc1, "0"   "1" *	Disable/enable command acknowledge.	"0" – acknowledge disabled. "1" – acknowledge enabled.
Auto-setup	0xc3	Start auto-setup of current vmode.	"0" – fail. "1" – successful.
Command availability	0xc4, n	Check whether a command is available.	"0" – not available. "1" – available.
Auto-calibration	0xc5	Start auto-calibration of gain of the RGB amplifier.	"0" – fail. "1" – successful.
Soft Power On/Off	0xc8, "0"   "1"   * "?"	Soft power On/off query	"0" – soft power off. "1" – soft power on.
Query video input status	0xc9	Query the status of the primary & pip status	"nn,nn" = input status "nn,xx" digit = primary status: "0", "0" : invalid "A" "1" : VGA  "xx,nn" = PIP input status: "0", "0" : invalid
Query BIOS version	0xcb, "0"	Read BIOS version	"nnnn" = BIOS ver. "nn.nn"
Query PCBA number	0xcb, "1"	Read PCBA number	"nnnn" = PCBA number DT-1920-VGA="41775"

Specifications subject to change without notice

Load factory defaults	0xce *	Reset all parameters to factory default value	"1" – successful.
-----------------------	--------	---	-------------------

Remark :

\* - This command writes to memory and therefore should not be set to write too frequently. We recommend no more than 1,000,000 times over a 3 year operating period.

# - Support on V1.00.00 firmware and later revision.

## - Support on V1.01.00 firmware or later revision.

#### Hex to ASCII conversion table

Hex	ASCII	Hex	ASCII	Hex	ASCII	Hex	ASCII
0x30	0	0x41	A	0x61	a	0x2B	+
0x31	1	0x42	B	0x62	b	0x2D	-
0x32	2	0x43	C	0x63	c	0x2E	.
0x33	3	0x44	D	0x64	d	0x3F	?
0x34	4	0x45	E	0x65	e		
0x35	5	0x46	F	0x66	f		
0x36	6	0x47	G	0x67	g		
0x37	7	0x48	H	0x68	h		
0x38	8	0x49	I	0x69	i		
0x39	9	0x4A	J	0x6A	j		
		0x4B	K	0x6B	k		
		0x4C	L	0x6C	l		
		0x4D	M	0x6D	m		
		0x4E	N	0x6E	n		
		0x4F	O	0x6F	o		
		0x50	P	0x70	p		
		0x51	Q	0x71	q		
		0x52	R	0x72	r		
		0x53	S	0x73	s		
		0x54	T	0x74	t		
		0x55	U	0x75	u		
		0x56	V	0x76	v		
		0x57	W	0x77	w		
		0x58	X	0x78	x		
		0x59	Y	0x79	y		
		0x5A	Z	0x7A	z		

---

## Appendix III – DDC/CI support at VGA port

This controller supports the following DDC/CI commands at VGA port :

- Brightness
- Contrast
- RGB Color
- Input Source (VGA)
- Horizontal/Vertical image position
- Color Temperature
- Clock phase
- Red/Green/Blue Gain for user setting
- Load factory default setting

## Appendix IV – Mapping definition

- Definition of Mapping A :

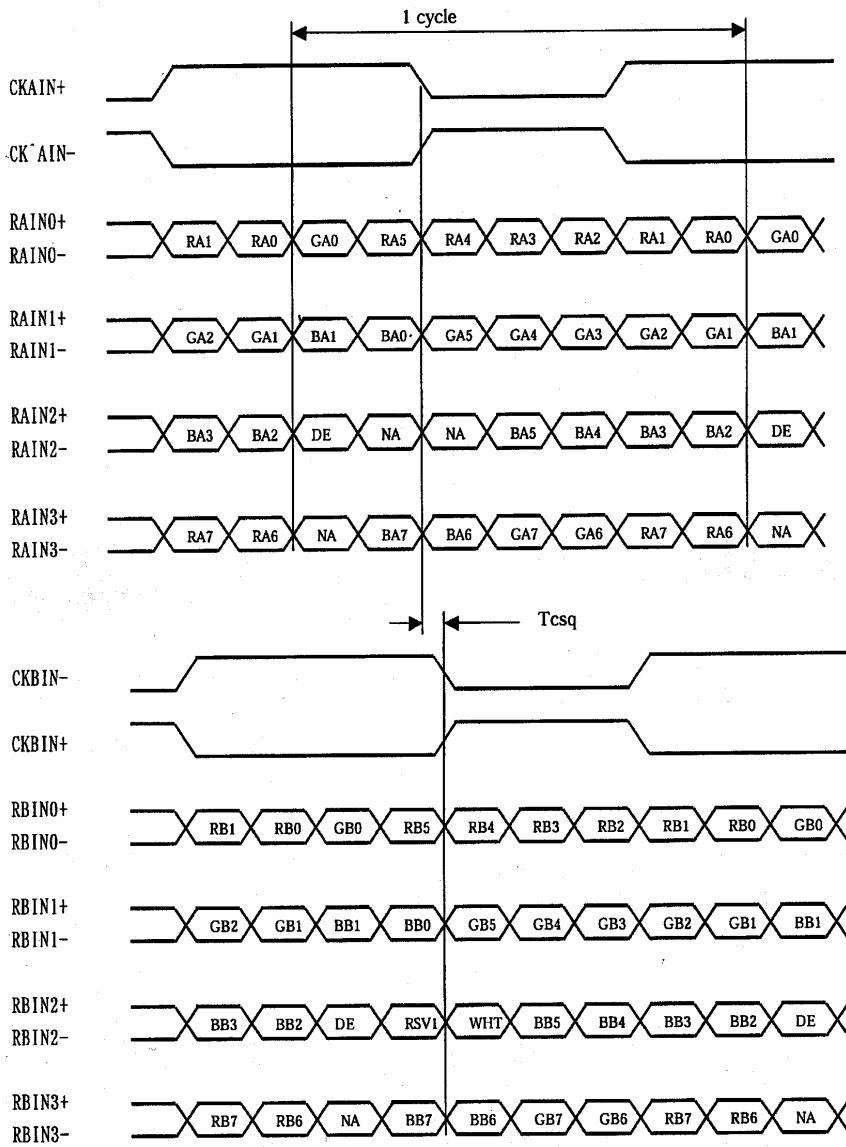

- Definition of Mapping B :

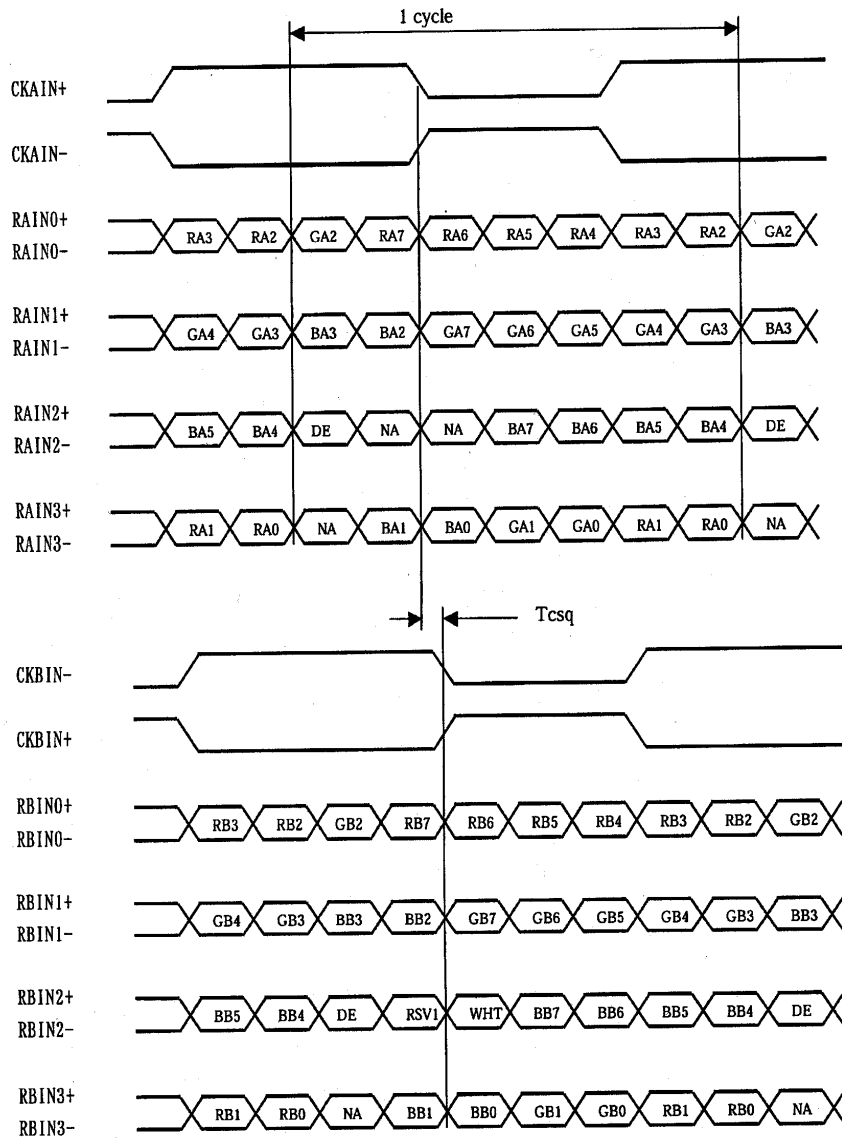

---

## Appendix V – Auto Color Gain

The Auto Color Gain function is supported in the ARGB mode only and is designed to calibrate the controller to the incoming video signal. In order to calibrate correctly, the display must be displaying an image containing both black and white data (see illustration below) when the function is used. The internal processor of the video controller chip will then execute a process to adjust the relative values of the RGB signals to achieve the best performance. The parameters of the corrected RGB values are then stored in the controller and are unaffected by the Reset Factory Defaults function.



**Warning** - If the Auto Color Gain is executed without an appropriate image being displayed, then the process will set incorrect values and the display colors will be distorted. If this occurs, then it can either be corrected by performing the process correctly or if this is not possible then the Reset Color Gain function can be used. This function will reset the stored RGB values to a set of approximate values.

## Appendix VI – DV remote control unit work for DT-1920-VGA

**P/N 5590001xx-3**  
DigitalView remote control unit  
(without DV logo silk screen  
printing)



BUTTON	FUNCTION
POWER BUTTON	Soft power ON/OFF button.
ATTENTION BUTTON	Use combined with digit keys to enable/disable the IR function. DT-1920-VGA : "Attention" + "1"
MUTE BUTTON (MUTE)	Switch to mute on/off mode.
SEL UP (▲) / SEL DN (▼)	Press this button to select the items in the OSD menu.
VOLUME (+/-) BUTTON	Press the "+" button to increase the volume and the "-" to decrease the volume.
+ / - BUTTON	Use "+" button to direct control the hotkey function for switching to next input source. In OSD menu, pressing this button to adjust the settings.
DISPLAY BUTTON	Activate the OSD menu display on screen.



## Appendix VII – Light Sensor Function work for DT-1920-VGA

DT-1920-VGA (Start from V1.00.00 firmware and later) provides an interface to enable automatic backlight adjustment. It is possible to connect with a light sensor directly to the controller board.

Use of the light sensor board P/N 416021310-3 and light sensor cable P/N 426305900-3 connect to the DT-1920-VGA via CN6 connector as shown below :

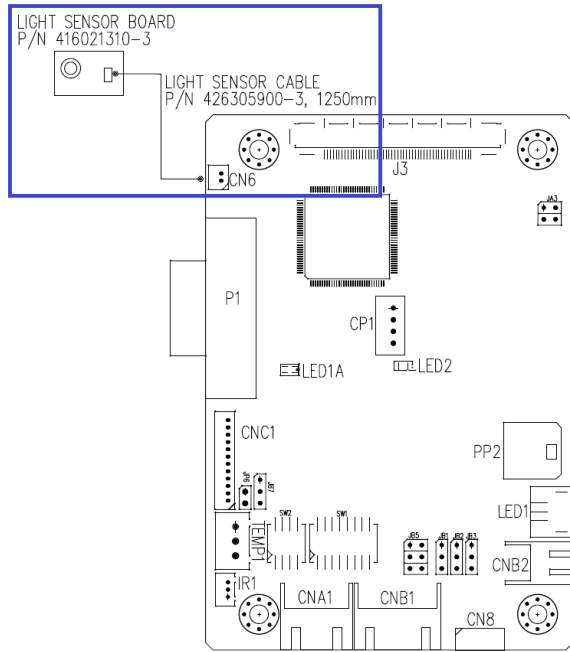

Digital View provides a user-friendly software program (TCP-IP Serial Utility V1.09 or later revision or Controller Utility V1.34 or later revision) can set thresholds for ambient light and the LCD panel backlight adjustment.

The settings can be Open/Save as by file.

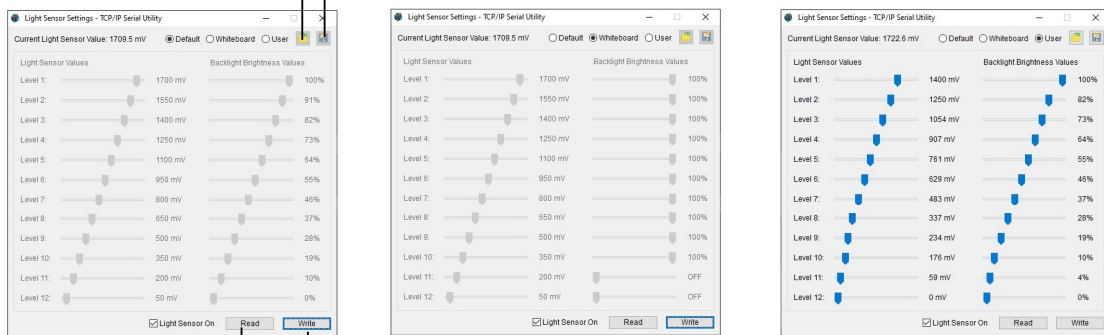

Read the current settings from controller

Confirm to write the current settings onto controller

Three auto dimming modes:

- Default - All the dimming level are preset as linear backlight %.
- Whiteboard - When room light 'ON', set backlight 100%, otherwise 'OFF' the backlight.
- User - Only this mode can be user configurable.

When designing a monitor a light sensor can be placed in a suitable location to detect changes in lighting and adjust the LCD panel backlight brightness appropriately.

## Appendix VIII – Temperature Sensor Function work for DT-1920-VGA

DT-1920-VGA (Start from V1.00.00 firmware and later) provides two ways to read the temperature :

- (1) On-board temperature sensor
- (2) External temperature sensor.

(1) : On Board Temperature sensor :

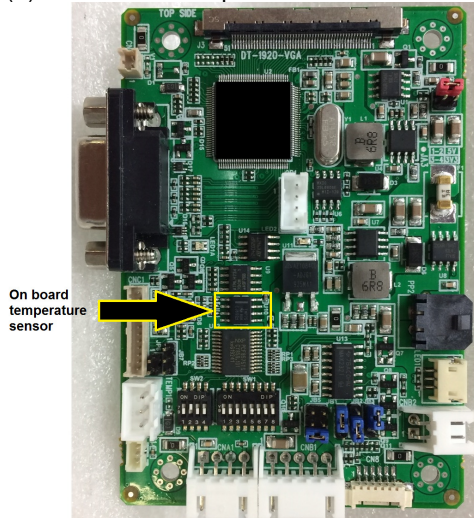

It provides three ways to read the on-board temperature value :

a) : Use Controller Utility Program version (V1.34 or up revision). The on-board temperature reading shown on the program indicated below :



b) Use TCP/IP Serial Utility Program version (v1.09 or up revision). The external

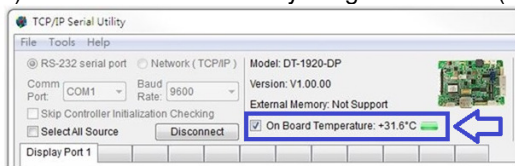

c) RS-232 command :

Query on board temperature sensor value	0xee,0x70,0x50,0x3B 0x34,0x3F	Query value	e.g. +25.6 → 0x2B 0x30 0x31 0x39 0x2E 0x36 )
---	-------------------------------	-------------	--

(2) External temperature sensor :

Use of the temperature sensor board P/N 416021320-3 and temperature sensor cable P/N 426004900-3 connect to the DT-1920-VGA via TEMP1 connector as shown below :

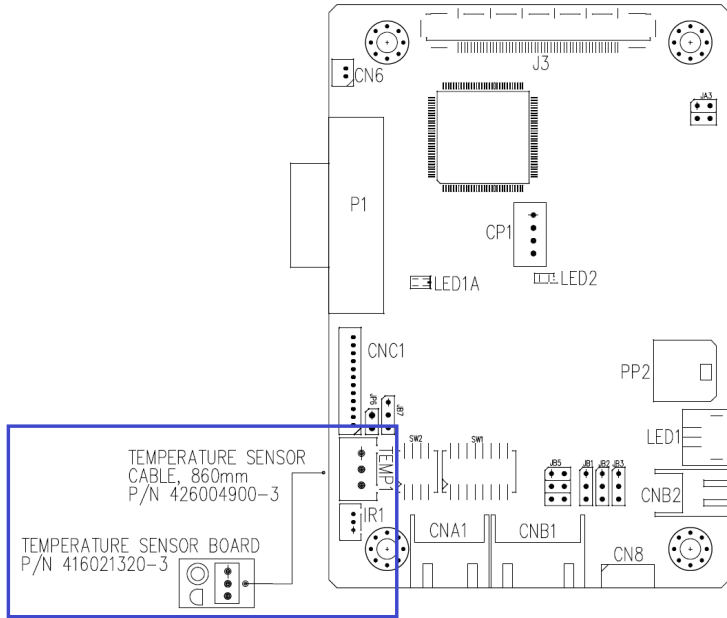

Read the external temperature sensor value via RS-232 command :

Query External Temp. Sensor value	0xee,0x70,0x50,0x3B 0x35,0x3F	Query value	e.g. -25.6 → 0x2D 0x30 0x31 0x39 0x2E 0x36 )
-----------------------------------	-------------------------------	-------------	--

---

## **WARRANTY**

The products are warranted against defects in workmanship and material for a period of three (3) year from the date of purchase provided no modifications are made to it and it is operated under normal conditions and in compliance with the instruction manual.

The warranty does not apply to:

- Product that has been installed incorrectly, this specifically includes but is not limited to cases where electrical short circuit is caused.
- Product that has been altered or repaired except by the manufacturer (or with the manufacturer's consent).
- Product that has subjected to misuse, accidents, abuse, negligence or unusual stress whether physical or electrical.
- Ordinary wear and tear.

Except for the above express warranties, the manufacturer disclaims all warranties on products furnished hereunder, including all implied warranties of merchantability and fitness for a particular application or purpose. The stated express warranties are in lieu of all obligations or liabilities on the part of the manufacturer for damages, including but not limited to special, indirect consequential damages arising out of or in connection with the use of or performance of the products.

---

## **CAUTION**

Whilst care has been taken to provide as much detail as possible for use of this product it cannot be relied upon as an exhaustive source of information. This product is for use by suitably qualified persons who understand the nature of the work they are doing and are able to take suitable precautions and design and produce a product that is safe and meets regulatory requirements.

---

## **LIMITATION OF LIABILITY**

The manufacturer's liability for damages to customer or others resulting from the use of any product supplied hereunder shall in no event exceed the purchase price of said product.

---

## **TRADEMARKS**

The following are trademarks of Digital View Ltd:

- Digital View
- DT-1920-VGA

---

## CONTACT DETAILS

Digital View has offices in Asia, Europe and USA also an internet site:

### USA

Digital View Inc.  
18440 Technology Drive  
Building 130  
Morgan Hill,  
California, 95037  
USA

**Tel:** (1) 408-782 7773      **Fax:** (1) 408-782 7883

**Sales:** [ussales@digitalview.com](mailto:ussales@digitalview.com)

### EUROPE

Digital View Ltd.  
The Lake House  
Knebworth Park  
Herts, SG3 6PY  
UK

**Tel:** +44-(0)20-7631-2150      **Fax:** +44-(0)20-7631-2156

**Sales:** [uksales@digitalview.com](mailto:uksales@digitalview.com)

### ASIA

Digital View Ltd  
Unit 705-708, 7/F Texwood Plaza  
6 How Ming Street  
Kwun Tong  
Hong Kong

**Tel:** (852) 2861 3615      **Fax:** (852) 2520 2987

**Sales:** [hksales@digitalview.com](mailto:hksales@digitalview.com)

### WEBSITE

[www.digitalview.com](http://www.digitalview.com)

## Revision History

Date	Rev No.	Page	Summary
15 July 2020	1.0	All	First issue
17 Jan 2023	2.0	7, 13, 23	Page 7 : Changed "+" / "-" button to control the Backlight brightness hotkey function. Page 13 : Add new panels support : - KOE TX26D202VM0BAA - NEC NL12876BC26-25 - NEC NL10276BC24-21F - NEC NL10276BC20-04 - KOE TX20D208VM0BAA Page 23 : Add two new RS-232 commands (Saturation - '0x83' and Hue - '0x84')