



HDMI, DISPORT PORT INTERFACE CONTROLLER FOR TFT PANEL

Model: DT-4096

Part number : 41782002X-3 or up

INSTRUCTIONS

CONTENTS

Page:	2. Introduction, How to Proceed, Usage Note, Disclaimer
	3. System design – Diagram of a suggested system
	4. Assembly notes – Important information about system elements
	6. Connection & Operation – How to use the controller
	10. Connectors, pinouts & jumpers – Essential connection information
	18. Controller dimensions
	19. Application notes
	21. Troubleshooting
	22. Specifications
	23. Appendix I – Supported graphics modes table
	25. Appendix II – RS-232 control protocols
	34. Appendix III – DDC/CI support at HDMI & Display port
	35. Appendix IV – DV remote control unit work for DT-4096
	36. Appendix V – Light Sensor Function work for DT-4096
	37. Warranty, Caution & Limitation of Liability, Trademarks
	38. Contact details
	39. Revision History

It is essential that these instructions are read and understood before connecting or powering up this controller.

Introduction

Designed for LCD monitor and other flat panel display applications, the DT-4096 is a feature rich interface controller for :

- TFT (active matrix) LCD panels of 4096x2160 resolutions in 60Hz with V-by-One or eDP interface.
- Support true 10 bits panel
- Support HDMI, Display Port input.

Ordering information :

Controller	Part number	Ordering part number
DT-4096	P/N 41782002X-3	P/N 4178200XX-3

HOW TO PROCEED

- Ensure you have all parts & that they are correct, refer to:
 - Connection diagram

Controller Solution Generator

Full web resource matching controllers & panels with **connection diagrams** for download.
See at : <http://www.digitalview.com/csg>

- Connector reference (in following section)
- Assembly notes
- Check controller switch & jumper settings (errors may damage the panel)
- Prepare the PC
- Connect the parts
- Understand the operation & functions

IMPORTANT USAGE NOTE

This equipment is for use by developers and integrators, the manufacturer accepts no liability for damage or injury caused by the use of this product. It is the responsibility of the developer, integrators or other user of this product to:

- Ensure that all necessary and appropriate safety measures are taken.
- Obtain suitable regulatory approvals as may be required.
- **Check power settings to all component parts before connection.**

DISCLAIMER

There is no implied or expressed warranty regarding this material.

SYSTEM DESIGN

A typical LCD based display system utilizing this controller is likely to comprise the following:

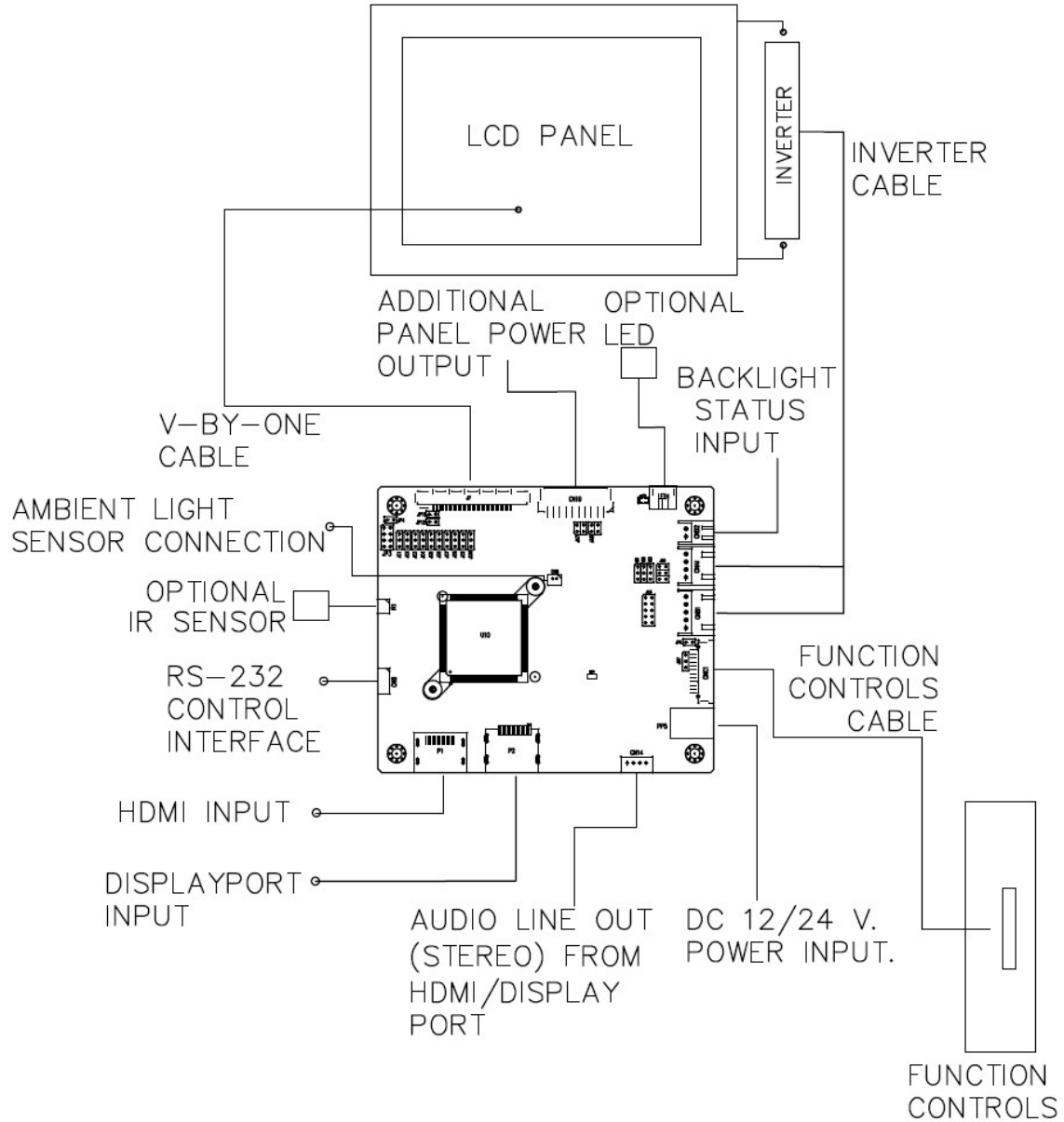

ASSEMBLY NOTES

This controller is designed for monitor and custom display projects using 4096x2160 resolution with V-by-One or eDP interface TFT panels. The following provides some guidelines for installation and preparation of a finished display solution.

Preparation: Before proceeding it is important to familiarize yourself with the parts making up the system and the various connectors, mounting holes and general layout of the controller. As much as possible connectors have been labeled. Guides to connectors and mounting holes are shown in the following relevant sections.

1. **LCD Panel:** This controller is designed for typical V-by-One (8 lanes) or eDP interfaced panels with panel voltage 3.3V(4A), 5V(4A), 10V(4A), 12V(4A) or 18V(3A). Due to the variation between manufacturers of panels signal timing and other panel characteristics, factory setup and confirmation should be obtained before connecting to a panel. **(NOTE: Check panel power jumper settings before connection)**
2. **LCD Controller:** Handle the controller with care as static charge may damage electronic components. Make sure correct jumper to match the target LCD panel.
3. **Panel cable:** In order to provide a clean signal it is recommended that all panel cables (V-by-One or eDP signal) supplied by Digital View. Care should be taken when placing the cables to avoid signal interference.
4. **Backlight driver:** This will be required for the backlight of an LCD, some LCD panels have a backlight driver built in. As LCD panels may have 1 or more backlight tubes and the power requirements for different panel backlights may vary it is important to match the backlight driver in order to obtain optimum performance. See Application notes page 23 for more information on connection.
5. **Backlight cables:** Different backlight models require different cables and different pin assignment. Make sure correct cable pin out to match the backlight. Using wrong cable pin out may damage the backlight.
6. **Function Controls:** The following section discusses the controls required and the section on connectors provides the detail. The controls are minimal: On/Off, Backlight Brightness (depends on backlight), OSD (5 momentary buttons) analog VR type or (8 momentary buttons) digital type.
7. **Function controls cable:** The cables to the function switches should be of suitable quality and length so that impedance does not affect performance. Generally lengths up to 1 meter (3 feet) should be acceptable.
8. **Optional LED:** The pin direction of the LED should be corrected for right color indication. Red color stands for standby. Green colors stands for signal on. The status LED is an optional part only, can be unconnected.
9. **Optional IR sensor:** It is an optional part only, can be unconnected if not using IR remote control.
10. **RS-232 control interface :** Serial control via CN8 interface port.
11. **Ambient light sensor connection :** 2 ways connector provides interface for connection using light sensor cable (with sensor) P/N 426321940-3 (1000mm) or Light sensor board P/N 416021310-3/416021330-3 with light sensor cable P/N 426305900-3 (1250mm) via CN6 connector.
12. **Backlight status input :** 2 ways connector provides interface for connection with the specific panel type which support the panel with backlight status monitoring function.
13. **HDMI input :** Plug the HDMI cable to the connector P1(HDMI 2.0) on the controller board.
14. **Display Port input :** Support single-link Display port 1.2. Plug the Display Port cable to the connector P2 on the controller board.
15. **Additional panel power input :** Provide additional (+10V/+12V/+18V) panel power input for driving high power consumption panels.
16. **Power Input:** 12V/24VDC is required, this should be a regulated supply. The power rating is depending on the panel and inverter used. Normally, power supply with 3.5A current output should be enough for most of 4xCCFT panels. Although the controller provides power regulation for the LCD power this does not relate to the power supplied to the backlight driver. If an unregulated power supply is provided to an inverter any fluctuations in power may affect operation, performance and lifetime of the inverter and or backlight tubes.
 - **Power output:** Note the controller has an overall 3A current limit and the current available from the auxiliary power output will be dependent on the power input and other system requirements.
 - **Power Safety:** Note that although only 12V / 24VDC is required as 'power-in' a backlight driver for panel backlighting produces significantly higher voltages (the inverter does not connect to the ground plane). We strongly advise appropriate insulation for all circuitry.
 - **EMI:** Shielding will be required for passing certain regulatory emissions tests. Also the choice of external Controller to PC signal cable can affect the result.

Specifications subject to change without notice

- **Ground:** The various PCB mounting holes are connected to the ground plane.
- **Servicing:** The board is not user serviceable or repairable. Warranty does not cover user error in connecting up to the controller and is invalidated by unauthorized modification or repairs.
- **Controller Mounting:** It is recommended that a clearance of at least 10mm is provided above and 5mm below the controller when mounted. Additionally consideration should be given to:
 - Electrical insulation.
 - Grounding.
 - EMI shielding.
 - Cable management. Note: It is important to keep panel signal cables apart from the inverter & backlight cables to prevent signal interference.
 - Heat & Ventilation: Heat generated from other sources, for example the backlight of a very high brightness panel may generate significant heat which could adversely affect the controller.
 - Other issues that may affect safety or performance.
- **PC Graphics Output:** A few guidelines:
 - Signal quality is very important, if there is noise or instability in the PC graphics output this may result in visible noise on the display.
 - Refer to graphics modes table in specifications section for supported modes.
 - Non-interlaced & interlaced video input is acceptable.

IMPORTANT: Please read the Application Notes section for more information.

CONNECTION & OPERATION

CAUTION: Never connect or disconnect parts of the display system when the system is powered up as this may cause serious damage.

CONNECTION

Connection and usage is quite straight forward (it is useful to have the relevant connection diagram available at this time):

1. **LCD panel & backlight:** Connect the inverter/Backlight driver (if it is not built-in the panel) to the inverter/backlight connector of the LCD panel.
2. **V-by-One interface/eDP panels:** The controller board supports V-by-One / eDP interface 4K panel. Plug the cable to J7 for driving 4K 60Hz panel. And make sure the matching panel timings and correct jumper settings (JC1-JC10) by referring to the panel support table and jumper settings table in page 12-16.
3. **Backlight driver:** Plug the backlight cable to CNB1 and CNA1 (if necessary). Plug another end to the connector on the backlight of panel side.
4. **Function switch & Controller:** Plug the OSD switch mount cable to CNC1 on the controller board and another to the OSD switch mount.
5. **LED & Controller:** Plug in a 3-way with dual color LED to connector LED1 on the controller board.
6. **IR & Controller:** Plug in a 3-way with IR sensor to connector IR1 on the controller board.
7. **Jumpers & backlight & Panel voltage:** Particularly pay attention to the settings of JA3, JA7, JA8, JB2 and JB3. JB2 & JB3 are used for backlight control (read backlight specification and information on the jumper table to define the correct settings). JA3, JA7 and JA8 are used for panel voltage input (read panel specification and information on the jumper table to define the correct settings).
8. **Input signal cable & Controller:** Plug the corresponding signal input to the connector on the controller board.
9. **Power supply & Controller:** Plug the DC 12V/24V power in to the connector PP5. You can consider to use DigitalView mating power cable P/N 426013710-3, 1000mm for PP5 connection.
10. **Power on:** Switch on the controller board and panel by using the OSD switch mount.

Controller LED status (LED1/LED1A) :

State	LED color
Valid video signal received on the selected input port.	Green
(1) No video signal received on the selected input port. (2) Soft power off.	Red
The board is fail to boot up. Suggest to send it back to factory for check.	Green + Red
The board is not powered on.	Off

Controller LED status (LED5) :

Panel power output status	LED color
Panel power is supplied to panel.	Red
No power is supplied to panel.	Off

General:

- If you are using supplied cables & accessories, ensure they are correct for the model of panel and controller.
- If you are making your own cables & connectors refer carefully to both the panel & inverter specifications and the section in this manual, "Connectors, Pinouts & Jumpers" to ensure the correct pin to pin wiring.

PC SETTINGS

The controller has been designed to take a very wide range of input signals however to optimize the PC's graphics performance we recommend choosing 60Hz vertical refresh rate – this will not cause screen flicker.

OPERATION

Once the system has been connected and switched on there are a number of functions available to adjust the display image as summarized in the following sections. The settings chosen will be saved for each mode independently.

LCD DISPLAY SYSTEM SETTINGS

NOTE: By way of explanation the following refers to a set of sample buttons that may be obtained as an option. In addition to power on/off and connection for backlight brightness the controller provides an On Screen Display of certain functions which are controlled by 5 momentary type buttons (analog VR type) or 8 momentary type buttons (digital type):

Controls	Digital type	5 button OSD switch mount board
On/Off – turns controller board power on	On/Off button	-
Brightness – controls backlight brightness	Brightness +/- buttons	-
Menu • Turns OSD menu On or Off (it will auto time off)	Menu button	Menu button
Select up • Moves the selector to the previous level function (up)	SEL UP	SEL UP
Select down • Moves the selector to the next level function (down) • Confirm the OSD selection	SEL DN	SEL DN
+ • Increase the OSD parameter values • Moves the selector to next function (forward)	+	+
- • Decrease the OSD parameter values • Moves the selector to previous function (backward)	-	-
Reset to Factory Defaults	Press and hold SEL DN button, then power on the controller	Press and hold SEL DN button, then power on the controller
Soft power off and on	Hold Menu button for 3-4 seconds. Press Menu button to turn back on.	Hold Menu button for 3-4 seconds. Press Menu button to turn back on.

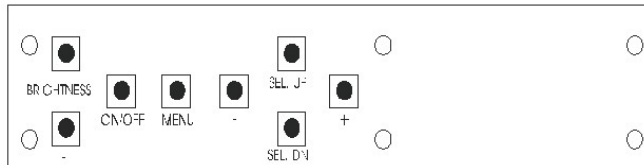

Digital type



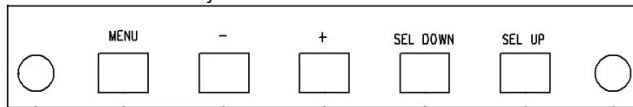

Digital 10K Type OSD switch mount
P/N 416100520-3 or up,
matching cable
P/N 426122200-3.





5 keys OSD switch mount board



5 buttons OSD switch mount board P/N 4161003700-3,
matching cable
P/N 426123010-3.

OSD functions

 <p>Picture</p>	<p>Picture:</p> <p>Brightness [0-100] [Default 100] Black level [0-100] [Default 50] Contrast [0-100] [Default 50] Sharpness [0-4] [Default 2]</p>
 <p>Display</p>	<p>Display:</p> <p>Disp Rotate : 0 / 180 (Rotate the image only, OSD menu not rotated)</p>
 <p>Color</p>	<p>Color:</p> <p>Gamma : 1.8 2.0 2.2 [Default] 2.4 2.6</p> <p>Temperature: 9300 7500 6500 [Default] 5800 sRGB User : R [0-255] G [0-255] B [0-255]</p> <p>Hue: [0-100] [Default 50] Saturation [0-100] [Default 50]</p>
 <p>Advanced</p>	<p>Advanced:</p> <p>Aspect Ratio: Full [Default] 16:9 4:3 5:4 1:1</p> <p>Auto Source Seek: OFF ON [Default]</p> <p>Hot Key: Hot Key 1 (+ -) : Input Brightness [Default] Black level Contrast Sharpness Hue Saturation Aspect Ratio Volume No Function</p> <p>Hot Key: Hot Key 2 (Up Dn) : Input [Default] Backlight Brightness Contrast Sharpness Hue Saturation Aspect Ratio Volume No Function</p> <p>Power Save: OFF ON [Default]</p>

	<p>Default Power: OFF ON [Default]</p>
 <p>Input</p>	<p>Input:</p> <p>D0 : DP D1 : HDMI</p>
 <p>Audio</p>	<p>Audio:</p> <p>Volume [0-100] [Default 50]</p> <p>Mute: ON OFF [Default]</p>
 <p>Other</p>	<p>Other:</p> <p>Reset</p> <p>Menu Time [On, 11-60] [Default 11]</p> <p>OSD H Position [0-100] [Default 50]</p> <p>OSD V Position [0-100] [Default 50]</p> <p>Transparency [0-255] [Default 0]</p> <p>Rotate: 0 [Default 0] Rotate the OSD menu 90 270 180</p>
 <p>Information</p>	<p>Information:</p> <div style="border: 1px solid gray; padding: 5px; width: fit-content; margin: 10px auto;"> <p>D1: HDMI 3840x2160@60.1Hz H:135.1kHz PCLK: 594.4MHz HDCP Disabled</p> </div>
 <p>Factory</p>	<p>Factory:</p> <p>Backlight Setup: Invert : OFF [Default] ON</p> <p>D/A / PWM : PWM [Default] D/A</p> <p>Frequency : [100Hz - 440Hz] [Default 160Hz]</p> <p>Min. Level : [0% - 50%] [Default 5%]</p> <p>Light sensor OFF/ ON [Default OFF]</p> <p>EDID Setup : Reset</p>

Firmware V1.00.00.02 or up

CONNECTORS, PINOUTS & JUMPERS

The various connectors are:

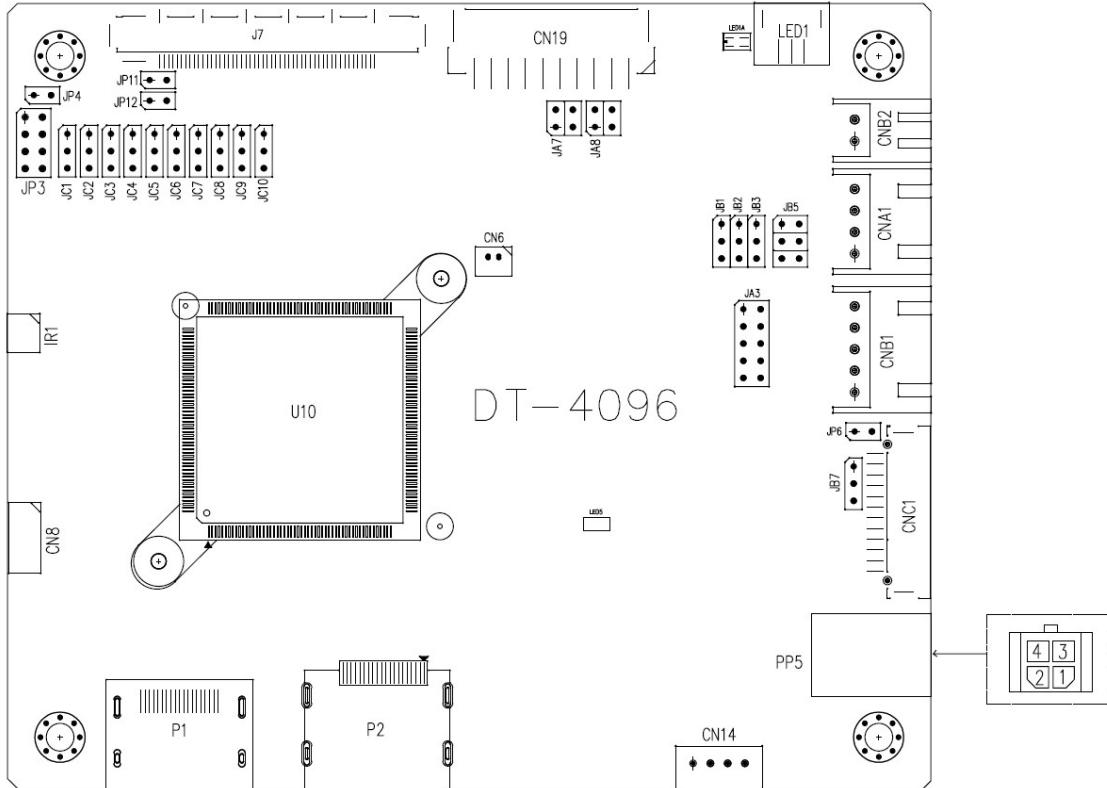

Summary: Connectors

Ref	Purpose	Description
CN6	Ambient light sensor connector	Hirose DF13-2P-1.25DSA (Mating type : DF13-2S-1.25C)
CN8	Serial control	Molex 53261-0671 compatible, 6 ways 1.25mm pitch (Mating type : Molex 51021-0600) (Matching connection cable P/N 426171800-3)
CN14	Analog (Stereo) audio out	JST B4B-PH-K compatible (Matching type : PHR-4) (Matching connection cable P/N 426002500-3 (RCA plug, 610mm) or P/N 426002600-3 (RCA jack, 150mm))
CN19	Additional panel power output	JST S10B-PH-SM4-TB or compatible (Matching type : PHR-10)
CNA1	Auxiliary power output	JST 4-way, S4B-XH-A or compatible (Matching type : XHP-4) (Matching cable P/N 426040200-3)
CNB1	Backlight inverter	JST 5-way, S5B-XH-A or compatible (Matching type : XHP-5) (Matching cable P/N 426058300-3)
CNB2	Backlight status input connector	JST 2 way, S2B-XH-A or compatible (Matching type : XHP-2) (Matching cable P/N 426020800-3)
CNC1	OSD control	Hirose DF13A-12P-1.25H (Mating type : DF13-12S-1.25C) (For 8 buttons OSD switch mount (P/N 416100520-3): Matching OSD switch mount cable P/N 426122200-3 (150mm) or 426122210-3 (250mm) For 5 buttons OSD switch mount (P/N 416103700-3): Matching OSD switch mount cable P/N 426123010-3)
IR1	Infra-red sensor connector	Molex 53261-0371 or compatible (Mating type : 51021-0300) (Matching connection cable P/N 426031500-3)
J7	V-by-One/eDP panel signal output	JAE FI-RE51S-HF (Matching type : FI-RE51HL)
LED1	Dual color LED connector	JST S3B-ZR-SM4A or compatible (Mating type : ZHR-3) (Matching connection cable P/N 426031400-3)
P1	HDMI (2.0) -- HDMI input	HDMI connector (Type A)
P2	Displayport input	Display port connector
PP5	12V/24VDC input power	Molex 43045-0400 compatible (Matching connector type : Molex 43025-0400 compatible) (Matching power cable : P/N 426013710-3)

All connectors used may use the compatible type.

Specifications subject to change without notice

Summary: Jumpers setting

Ref	Purpose	Note																																																
JA3	Panel power voltage select CAUTION: Incorrect setting can damage panel	See panel voltage setting table 1																																																
JA7	Panel power voltage select CAUTION: Incorrect setting will cause panel damage	See panel voltage setting table 1																																																
JA8	Panel power voltage select CAUTION: Incorrect setting will cause panel damage	See panel voltage setting table 1																																																
JB1	Backlight brightness voltage range	1-2 closed = 5V max 2-3 closed = 3.3V max																																																
JB2	Backlight inverter on/off control – signal level	2-3 = On/Off control signal 'High' = +5V 1-2 = On/Off control signal 'High' = +3.3V Open = On/Off control signal 'High' = Open collector CAUTION: Incorrect setting can damage inverter.																																																
JB3	Backlight inverter on/off control – polarity	1-2 = control signal 'high' = CCFT ON 2-3 = control signal 'low' = CCFT ON																																																
JB5	Backlight control type selection	1-2 = VR/Digital switch mount control 3-4 = Analog backlight brightness - voltage range 0~5V 5-6 = PWM (Pulse Width Modulation) brightness																																																
JB7	Backlight control voltage on CNB1 pin 4 (Function when JB5 sets 1-2 closed)	Open = For OSD switch mount control (Default) 1-2 = 0V 2-3 = 3.3V / 5V controlled by JB1																																																
JC1-JC10	<p>Panel Specification (V-by-One's pin assignment)</p> <table border="1"> <thead> <tr> <th>Pin</th> <th>Name</th> <th>Description</th> </tr> </thead> <tbody> <tr><td>12</td><td>GND</td><td>Ground</td></tr> <tr><td>13</td><td>GND</td><td>Ground</td></tr> <tr><td>14</td><td>GND</td><td>Ground</td></tr> <tr><td>15</td><td>NC</td><td>NO CONNECTION</td></tr> <tr><td>16</td><td>NC</td><td>NO CONNECTION</td></tr> <tr><td>17</td><td>NC</td><td>NO CONNECTION</td></tr> <tr><td>18</td><td>NC</td><td>NO CONNECTION</td></tr> <tr><td>19</td><td>NC</td><td>NO CONNECTION</td></tr> <tr><td>20</td><td>NC</td><td>NO CONNECTION</td></tr> <tr><td>21</td><td>NC</td><td>NO CONNECTION</td></tr> <tr><td>22</td><td>NC</td><td>NO CONNECTION</td></tr> <tr><td>23</td><td>NC</td><td>NO CONNECTION</td></tr> <tr><td>24</td><td>GND</td><td>Ground</td></tr> <tr><td>25</td><td>HTPDN</td><td>Hot plug detect</td></tr> <tr><td>26</td><td>LOCKN</td><td>Lock detect</td></tr> </tbody> </table>	Pin	Name	Description	12	GND	Ground	13	GND	Ground	14	GND	Ground	15	NC	NO CONNECTION	16	NC	NO CONNECTION	17	NC	NO CONNECTION	18	NC	NO CONNECTION	19	NC	NO CONNECTION	20	NC	NO CONNECTION	21	NC	NO CONNECTION	22	NC	NO CONNECTION	23	NC	NO CONNECTION	24	GND	Ground	25	HTPDN	Hot plug detect	26	LOCKN	Lock detect	<p>1-2 close = High 2-3 close = Low or GND Open = NC</p> <p>* The setting of NC (No connection) is subject to the NC's state defined in panel specification.</p>
Pin	Name	Description																																																
12	GND	Ground																																																
13	GND	Ground																																																
14	GND	Ground																																																
15	NC	NO CONNECTION																																																
16	NC	NO CONNECTION																																																
17	NC	NO CONNECTION																																																
18	NC	NO CONNECTION																																																
19	NC	NO CONNECTION																																																
20	NC	NO CONNECTION																																																
21	NC	NO CONNECTION																																																
22	NC	NO CONNECTION																																																
23	NC	NO CONNECTION																																																
24	GND	Ground																																																
25	HTPDN	Hot plug detect																																																
26	LOCKN	Lock detect																																																
JP3	Panel & function selection	See table 3																																																
JP4	Reserved	Default Open																																																
JP6	Input power control	Short = External switch control Open = Switch mount control																																																
JP11	Panel output power pin selection on J7	See panel output power pin selection table 2																																																
JP12	Panel output power pin selection on J7	See panel output power pin selection table 2																																																

Table 1 : Panel voltage setting table :

Input voltage via PP5	Panel Voltage	JA3	JA5	JA6	Jumper on board
12VDC	3.3V	3V3 closed	1-3 & 2-4	1-3 & 2-4	
	5V	5V closed	1-3 & 2-4	1-3 & 2-4	
	12V	OPEN	1-3 & 2-4	5-7 & 6-8	

CAUTION: Incorrect setting can damage panel & controller

* Maximum current for 3.3V, 5V = 4A,

Input voltage via PP5	Panel Voltage	JA3	JA5	JA6	Jumper on board
24VDC**	3.3V	3V3 closed	1-3 & 2-4	1-3 & 2-4	
	5V	5V closed	1-3 & 2-4	1-3 & 2-4	
	10V	10V closed	1-3 & 2-4	3-5 & 4-6	
	12V	12V closed	1-3 & 2-4	3-5 & 4-6	

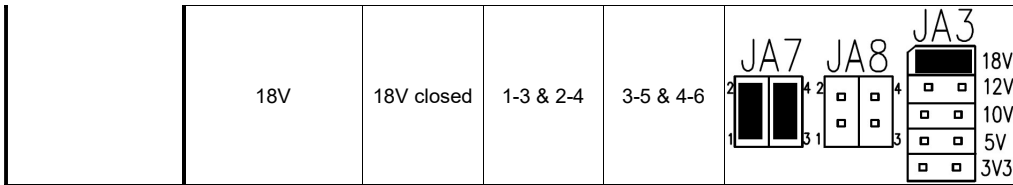

CAUTION: Incorrect setting can damage panel & controller

* Maximum current for 3.3V, 5V = 4A, Maximum current for 10V, 12V = 4A, Maximum current for 18V = 3A

JA3, JA7 & JA8 location on board : (Please pay attention to the jumper settings on JA3, JA7 & JA8 which are red in color)

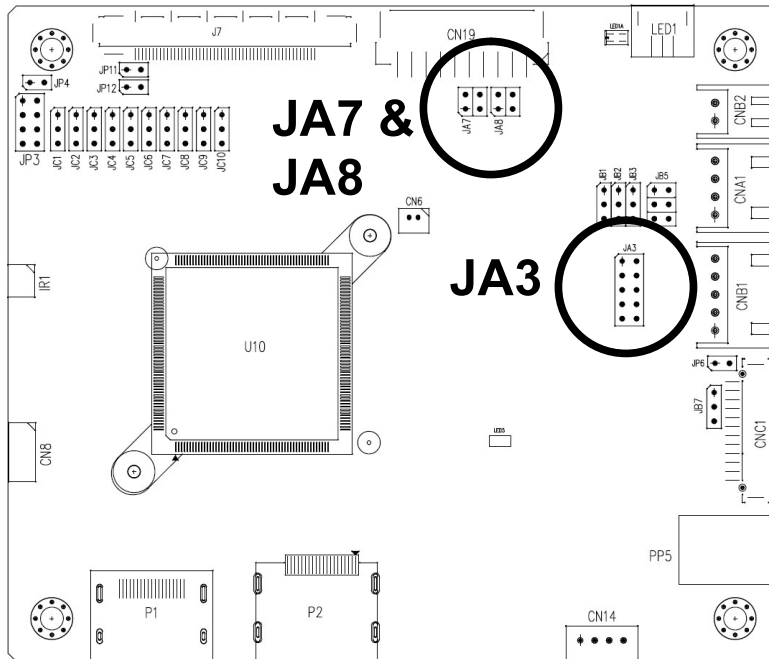
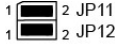

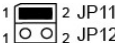

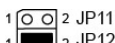

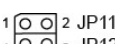



Table 2 : Panel Output power pin selection table (JP11 and JP12):

Output power pin selection on J7	JP11	JP12	Jumper on board
Pin-44 to Pin-51 (Pin-1 to Pin-8)*	1-2 CLOSE	1-2 CLOSE	 1  2 JP11 1  2 JP12
Pin-48 to Pin-51 (Pin-1 to Pin-4)*	1-2 CLOSE	1-2 OPEN	 1  2 JP11 1  2 JP12
Pin-44 to Pin-47 (Pin-5 to Pin-8)*	1-2 OPEN	1-2 CLOSE	 1  2 JP11 1  2 JP12
No power output on pins	1-2 OPEN	1-2 OPEN	 1  2 JP11 1  2 JP12

CAUTION: Incorrect setting can damage panel & controller

*Pin # read at panel side

Table 3 : Panel timings selection – JP3

JP3	Description	Panel resolution	Panel resolution
OPEN	Innolux M280DGJ-L30	3840x2160	V-by-1
1-2 closed	AU Optronics G270ZAN01.1	3840x2160	V-by-1
7-8 closed	BOE MV238QVM-N20	3840x2160	eDP

Remark : The above panel timings are generated based on the panel specification. Some of the panel timings settings may not exactly to match the panel model we specified in this table.

Support "Resolution default by EDID" for different resolution panel.

The controller will set the preferred timing based off the JP3 jumper setting selection, but also be able to go higher to 4096x2160. For example, if the panel is a 3840x2160 and the JP3 jumper setting is set for 3840x2160. The preferred EDID resolution should be 3840x2160. It should also have the capability to set the max resolution to 4096x2160.

CN6 – Ambient light sensor connector : Hirose DF13-2P-1.25DSA compatible (Mating type : DF13-2S-1.25C)

PIN	SYMBOL	DESCRIPTION
1	3.3V	3.3V
2	ALS	Ambient light sensing

CN8 – RS-232 serial control: Molex 53261-0671 compatible (Mating type : Molex 51021-0600)

PIN	SYMBOL	DESCRIPTION
1	EXT_MSTR2_SCL	Reserved
2	EXT_MSTR2_SDA	Reserved
3	VCC	+5V
4	TXD	RS-232 Tx data
5	GND	Ground
6	RXD	RS-232 Rx data

CN14 –Audio line out (Stereo) connector: JST B4B-PH-K compatible (Matching type : PHR-4)

PIN	SYMBOL	DESCRIPTION
1	GND	GND
2	AUDIO LOU	AUDIO LINE OUT LEFT
3	GND	GND
4	AUDIO ROU	AUDIO LINE OUT LEFT

CNA1 - Auxiliary power output: JST 4-way, S4B-XH-A compatible (Mating type : XHP-4)

PIN	SYMBOL	DESCRIPTION
1	AUX 12V / 24V	+12V / +24V DC, 500mA max
2	GND	Ground
3	GND	Ground
4	AUX 5V	+5V DC, 500mA max

CNB1 – Backlight inverter connector: JST 5-way, S5B-XH-A or compatible (Matching type : XHP-5)

PIN	SYMBOL	DESCRIPTION
1	GND	Ground
2	VBKL	+12V / +24V DC, backlight power supply
3	BLCTRL	On/Off control (enable) – see JB2 & JB3
4	BVR_WIP	Brightness VR – WIP
5	BVR_A	Brightness VR A

CNB2 – Backlight status input inverter connector: JST 2 way, S2B-XH-A or compatible (Matching type : XHP-2)

PIN	SYMBOL	DESCRIPTION
1	BL_STATUS	Backlight status (Normal = High)
2	GND	Ground

CNC1 – OSD switch mount control, Hirose DF13A-12P-1.25H (Mating type : DF13-12S-1.25C)

PIN	SYMBOL	DESCRIPTION
1	PSWIN	Power button A
2	SW_ON	Power button B
3	BVR_A	Backlight Brightness VR pin A
4	BVR_WIP	Backlight Brightness R pin WIP
5	BVR_B	Backlight Brightness VR pin B (470 ohm resistor to +5V Vcc)
6	GND	Ground
7	MENU	OSD menu
8	-/LEFT	OSD -/Left
9	+/RIGHT	OSD +/Right
10	SEL_DN	OSD Select down
11	SEL_UP	OSD Select up
12	NC	No connection

The VR for brightness depends on the inverter. The main power load for On/Off is handled by a relay on the controller.

IR1 – Infra-Red sensor connector: Molex 53261-0371 or compatible (Mating type : 51021-0300)

PIN	SYMBOL	DESCRIPTION
1	GND	Ground
2	VCC	+3.3V
3	IR Data	IR data

J7 – eDP panel signal output connector: JAE FI-RE51S-HF(Matching type :JAE FI-RE51HL)

PIN	SYMBOL	DESCRIPTION
1	(51) GND	Ground
2	(50) LANE7P_VB1_7P	Lane 7 (Positive)
3	(49) LANE7P_VB1_7N	Lane 7 (Negative)
4	(48) GND	Ground
5	(47) LANE6P_VB1_6P	Lane 6 (Positive)
6	(46) LANE6P_VB1_6N	Lane 6 (Negative)
7	(45) GND	Ground
8	(44) LANE5P_VB1_5P	Lane 5 (Positive)
9	(43) LANE5P_VB1_5N	Lane 5 (Negative)
10	(42) GND	Ground
11	(41) LANE4P_VB1_4P	Lane 4 (Positive)
12	(40) LANE4P_VB1_4N	Lane 4 (Negative)
13	(39) GND	Ground
14	(38) LANE3P_VB1_3P	Lane 3 (Positive)
15	(37) LANE3P_VB1_3N	Lane 3 (Negative)
16	(36) GND	Ground
17	(35) LANE2P_VB1_2P	Lane 2 (Positive)
18	(34) LANE2P_VB1_2N	Lane 2 (Negative)
19	(33) GND	Ground
20	(32) LANE1P_VB1_1P	Lane 1 (Positive)
21	(31) LANE1P_VB1_1N	Lane 1 (Negative)
22	(30) GND	Ground
23	(29) LANE0P_VB1_0P	Lane 0 (Positive)
24	(28) LANE0P_VB1_0N	Lane 0 (Negative)
25	(27) GND	Ground
26	(26) V_LOCK	No Connection (Internal Use)
27	(25) V_HPDP	Hot Plug Detect
28	(24) NC	No Connection (JC10 – No connection)
29	(23) NC	No Connection (JC9 – No connection)
30	(22) AUX_CH_P_1	Auxiliary Channel 1 (Positive)
31	(21) AUX_CH_N_1	Auxiliary Channel 1 (Negative)
32	(20) NC	No Connection (JC6 – No connection)
33	(19) NC	No Connection (JC5 – No connection)
34	(18) NC	No Connection (JC4 – No connection)
35	(17) NC	No Connection (JC3 – No connection)
36	(16) AUX_CH_P_2	Auxiliary Channel 2 (Positive)
37	(15) AUX_CH_N_2	Auxiliary Channel 2 (Negative)
38	(14) GND	Ground
39	(13) GND	Ground
40	(12) GND	Ground
41	(11) GND	Ground
42	(10) GND	Ground
43	(9) NC	No Connection
44	(8) PANEL_VCC	Panel power supply(selected by JP12)
45	(7) PANEL_VCC	Panel power supply(selected by JP12)
46	(6) PANEL_VCC	Panel power supply(selected by JP12)
47	(5) PANEL_VCC	Panel power supply(selected by JP12)
48	(4) PANEL_VCC	Panel power supply(selected by JP11)
49	(3) PANEL_VCC	Panel power supply(selected by JP11)
50	(2) PANEL_VCC	Panel power supply(selected by JP11)
51	(1) PANEL_VCC	Panel power supply(selected by JP11)

(1) - (51): Pin# read on panel side.

LED1 – Status LED connector: JST S3B-ZR-SM4A or compatible (Mating type : ZHR-3)

PIN	DESCRIPTION
1	Green LED pin (anode)
2	LED pin common (cathode)
3	Red LED pin (anode)

P1 – HDMI1 (HDMI 2.0) connector : HDMI connector (Type A)

PIN	SYMBOL	DESCRIPTION
1	DATA2+	TMDS Data2+
2	DATA2S	TMDS Data2 Shield
3	DATA2-	TMDS Data2-
4	DATA1+	TMDS Data1+
5	DATA1S	TMDS Data1 Shield
6	DATA1-	TMDS Data1-
7	DATA0+	TMDS Data0+
8	DATA0S	TMDS Data0 Shield
9	DATA0-	TMDS Data0-
10	CLK+	TMDS Clock+
11	CLK@	TMDS Clock Shield
12	CLK-	TMDS Clock-
13	NC	Reserved
14	NC	Reserved
15	SCL	SCL (I ² C Serial Clock for DDC)
16	SDA	SDA (I ² C Serial Data Line for DDC)
17	GND	Ground
18	+5V	HDMI +5 V power
19	HPDET	Hot Plug Detect

P2 – Display Port input

PIN	SYMBOL	DESCRIPTION
1	ML_Lane 3 (n)	Lane 3 (negative)
2	GND	Ground
3	ML_Lane 3 (p)	Lane 3 (positive)
4	ML_Lane 2 (n)	Lane 2 (negative)
5	GND	Ground
6	ML_Lane 2 (p)	Lane 2 (positive)
7	ML_Lane 1 (n)	Lane 1 (negative)
8	GND	Ground
9	ML_Lane 1 (p)	Lane 1 (position)
10	ML_Lane 0 (n)	Lane 0 (negative)
11	GND	Ground
12	ML_Lane 0 (p)	Lane 0 (positive)
13	CONFIG1	connected to Ground
14	CONFIG2	connected to Ground
15	AUX CH (p)	Auxiliary Channel (positive)
16	GND	Ground
17	AUX CH (n)	Auxiliary Channel (negative)
18	Hot Plug	Hot Plug Detect
19	GND	Ground
20	DP_PWR	Power for connector (3.3 V 500 mA)

PP5 – 12V/24VDC input power: Molex 43045-0400 compatible(Matching connector type : Molex 43025-0400 compatible)

PIN	DESCRIPTION
1	+12VDC / 24VDC in
2	Ground
3	+12VDC / 24VDC in
4	Ground

* All connectors used may use the compatible type.

CONTROLLER DIMENSIONS

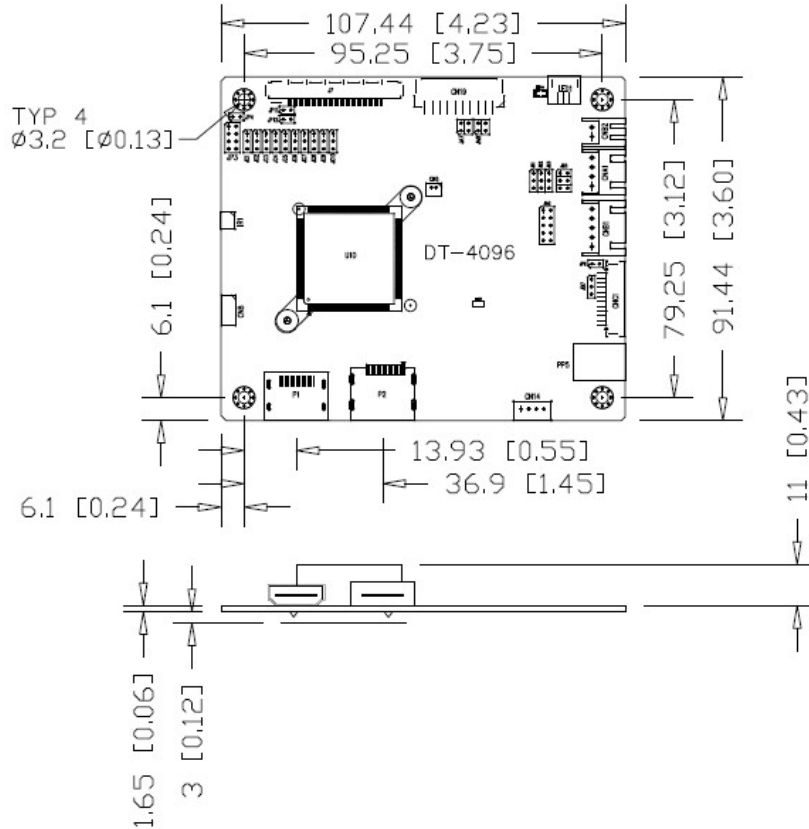

Ready-made 3D Pro-E (SLDPRT) drawing files - Save time and effort for your system volumetric analysis design. Includes jpg file previews. Please go to download at <https://digitalview.com/controllers/dt-4096-lcd-controller.html>

The maximum thickness of the controller is 18.9mm with or without video add-on board (measured from bottom of PCB to top of components, including any underside components & leads). We recommend clearances of:

- 5mm from bottom of PCB - if mounting on a metal plate we also recommend a layer of suitable insulation material is added to the mounting plate surface.
- 10mm above the components
- 3~5mm around the edges

Any of the holes shown above can be used for mounting the PCB, they are 3.2mm in diameter.

CAUTION: Ensure adequate insulation is provided for all areas of the PCB with special attention to high voltage parts such as the inverter.

APPLICATION NOTES

USING THE CONTROLLER WITHOUT BUTTONS ATTACHED

This is very straightforward:

- Firstly setup the controller/display system with the buttons. With controls attached and display system active make any settings for colour, tint and image position as required then switch everything off.
- Remove the control switches, the 12-way (CNC1) cable.
- Use a jumper or similar to connect pins 1 & 2 on CNC1, this will fix the board On.
- Refer to inverter specifications for details as to fixing brightness to a desired level, this may require a resistor, an open circuit or closed circuit depending on inverter.

Summary: On CNC1 the only pins that are used are for On/Off and Brightness (if controller mounted inverter is used). On CNC1 the pins are for momentary type buttons so it doesn't matter that no buttons are attached.

INVERTER CONNECTION

There are potentially 3 issues to consider with inverter connection:

- Power
- Enable
- Brightness

Please read the following sections for a guide to these issues.

Inverter Power: As per the table for CNB1 pin 1 is ground and pin 2 provides 12V/24V DC. This should be matched with the inverter specification: see table.

CNB1	
PIN	DESCRIPTION
1	Ground
2	+12V/+24VDC

Remark: For higher power inverter, more current (for 12V/24V) can be taken from CNA1 pin 1.

Enable: This is a pin provided on some inverters for On/Off function and is used by this panel controller for VESA DPMS compliance. If the inverter does not have an enable pin or the enable pin is not used then DPMS will not be operational. Pin 3 should be matched to the inverters specification for the 'enable' or 'disable' pin.

CNB1	
PIN	DESCRIPTION
3	Enable

Further, jumpers JB2 & JB3 should be set to match the inverters specification for the enable pin power and High or Low setting: see table.

Ref	Purpose	Note
JB2	Inverter enable voltage	1-2 H = 3.3V, 2-3 H = 5V, OPEN H = open collector
JB3	Inverter control	1-2 H = On, 2-3 L = On

Brightness: There are various methods for brightness control and it is important to consider the specifications for the inverter to be used. Generally the situation is:

- Brightness can control by using a resistor or VR (Variable Resistor).
- Brightness controlled by adding a circuit such as PWM (Pulse Width Modulation).
- No adjustment of brightness is possible.

CNB1 pins 4 & 5 are available for connecting to an inverter or circuit where VR control is supported.

CNB1	
PIN	DESCRIPTION
4	VR WIP
5	VR A

This can then be matched with function controls connected to CNC1 pins 4 & 3 or 5: see table.

CNC1	
PIN	DESCRIPTION
3	VR A
4	VR WIP
5	VR B

Specifications subject to change without notice

Design Guideline for making VR circuitry :

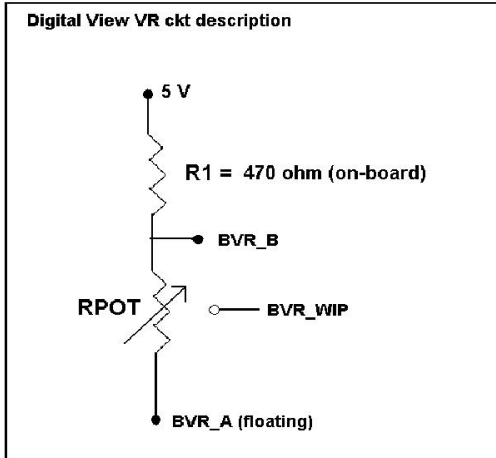

Signal description / Notes :

- 1) R1 : 470ohm on board
- 2) RPOT is an external potentiometer (in-line dip style) that can be plugged directly into CNC1 pins 3,4,5. RPOT must be supplied / installed by user.
- 3) BVR_B : Voltage tapped from “top” of potentiometer, the node of R1 and RPOT.
- 4) BVR_WIP : Voltage tapped from wiper arm of RPOT.
- 5) BVR_A : Voltage tapped from “bottom” of RPOT.

Note : BVR_A voltage is left floating on the controller board. To use this circuit, you need to tie this point to a potential (usually GND, available at CNC1 pin 6).

CNB1 – Backlight inverter connector: JST B5B-XH-A (Matching type : XHP-5)

PIN	SYMBOL	DESCRIPTION
1	GND	Ground
2	VBKL	+12V/24VDC, backlight power supply
3	BLCTRL	On/Off control (enable) – see JB2 & JB3
4	BVR_WIP	Brightness VR - WIP
5	BVR_A	Brightness VR A

CNC1 – OSD switch mount control, Hirose DF13A-12P-1.25H (Mating type : DF13-12S-1.25C)

PIN	SYMBOL	DESCRIPTION
1	PSWIN	Power button A
2	SW_ON	Power button B
3	BVR_A	Backlight Brightness VR pin A
4	BVR_WIP	Backlight Brightness R pin WIP
5	BVR_B	Backlight Brightness VR pin B (470 ohm resistor to +5V Vcc)
6	GND	Ground
7	MENU	OSD menu
8	-/LEFT	OSD -/Left
9	+ /RIGHT	OSD +/Right
10	SEL_DN	OSD Select down
11	SEL_UP	OSD Select up
12	NC	No connection

The VR for brightness depends on the inverter. The main power load for On/Off is handled by a relay on the controller.

Example for circuit design :

- 1.) Choose RPOT = 10K
- 2.) Tie BVR_A to GND
- 3.) Circuit analysis gives BVR_WIP as the following (see Figure 1)

$$BVR_WIP = 5 \times (Rbc/10.47)$$

where BVR_WIP is in Volts.
And Rbc is the resistance from the wiper arm to bottom of pot in Kohms.

To evaluate, plug in different values of Rbc :

Rbc	BVR_WIP
0	0 V
2.5 K	1.2 V
5 K	2.4 V
7.5 K	3.6 V
10 K	4.8 V

So this circuit could provide Brightness adjust voltage ranging from 0V to 5V.

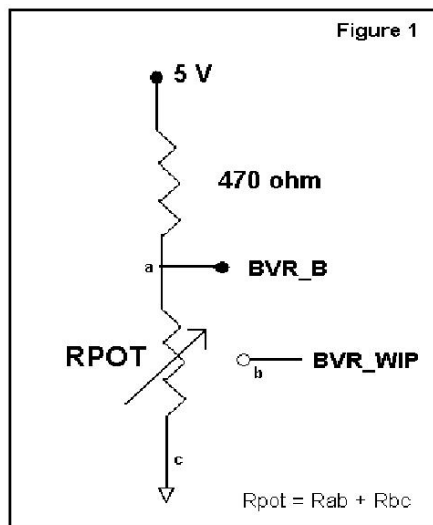

TROUBLESHOOTING

General

A general guide to troubleshooting a flat panel display system it is worth considering the system as separate elements, such as:

- Controller (jumpers, PC settings)
- Panel (controller, cabling, connection, panel, PC settings)
- Backlight (inverter, cabling, backlight tubes)
- Cabling
- Computer system (display settings, operating system)

Through step by step cross checking with instruction manuals and a process of elimination to isolate the problem it is usually possible to clearly identify the problem area.

No image:

- If the panel backlight is not working it may still be possible to just see some image on the display.
- A lack of image is most likely to be caused by incorrect connection, lack of power, failure to provide a signal or incorrect graphic card settings.

Image appearance:

- A faulty panel can have blank lines, failed sections, flickering or flashing display
- Incorrect graphics card refresh rate, resolution or interlaced mode will probably cause the image to be the wrong size, to scroll, flicker badly or possibly even no image.
- Incorrect jumper settings on the controller may cause everything from total failure to incorrect image. CAUTION: Do not set the panel power input incorrectly.
- Sparkling on the display: faulty panel signal cable.
- Found "Loading" message displayed on screen message at HDMI / DVI input indicates the unstable HDMI/DVI source detected (especially connected to HDMI splitter) causing flashing image.

Backlight:

Items to check include: Power input, Controls, Inverter and Tubes generally in this order.

If half the screen is dimmer than the other half:

- Check cabling for the inverter.
- For a specific backlight tube check the AC pins orientation (CAUTION: Never reverse any DC power pins).

Also:

- If adjusting brightness control has no effect the chances are that the VR rating or method of adjusting brightness is not compatible or correctly connected to the inverter.
- If system does not power down when there is a loss of signal

Continued failure:

If unit after unit keeps failing consider and investigate whether you are short circuiting the equipment or doing something else seriously wrong.

Generally after common sense issues have been resolved we recommend step by step substitution of known working parts to isolate the problem.

SPECIFICATIONS

Panel compatibility	Compatible with 4096x2160 resolutions of TFT LCD panels with V-by-One /eDP panel interface. A specified BIOS and some factory adjustment is required for individual panel timings.
No. of colors	Up to 3 x 10 bit providing 1.06 billion colors.
Panel power	DC 3.3V, 5V, 10V, 12V, 18V
Panel signal	V-by-One (8 Lane) eDP (8 lane HBR) / (4 lane HBR2)
Vertical refresh rate	60Hz at 1920x1200, 60Hz at 1920x1080, 60Hz at UXGA and up to 75Hz other lower resolution
Video inputs	HDMI 2.0 DisplayPort 1.2
Functions display	On screen display (OSD) of functions
OSD menu functions	Image controls: Panel brightness/contrast, Saturation, Hue, Color temperature, Sharpness, Aspect ratio, Rotate, Gamma.
OSD menu controls available	Power On/Off OSD Menu OSD Select up OSD Select down Setting + Setting -
Control interface	Buttons, RS-232, IR Remote control, DDC/CI
Settings memory	Settings are stored in non volatile memory
PC Connectivity	VGA / SVGA / XGA / SXGA / UXGA / WUXGA digital
Controller dimensions	107mm x 92mm
Power consumption	4w approx. (not including panel power consumption)
Power load maximum	The controller has an overall 3Amp current limit.
Input voltage	12V/24VDC +/- 5%
Power protection	Fuse fitted (Non resettable type)
Storage temperature limits	-40°C to +70°C
Operating temperature limits	0°C to +60°C
Calculated Mean Time Between Failures	In excess of 500,000 hours
Operating frequency (Crystal)	14.318MHz
Latency	12ms [#]
Use of memory on board	- 1 pc SD RAM 16Mbits & 36KB which is a volatile memory for frame buffer and OSD. - 1 pc flash 16Mbits which is a non-volatile memory for system program. - 1 pc EEPROM 128KBits which is a non-volatile memory for system setting storage. - 1 pc EEPROM 2KBits which is a non-volatile memory for HDMI EDID.

NOTES

Please note the following:

- For specific panel setup a sample of an LCD may be required (this will be returned) and a copy of the full technical specifications for the panel from the manufacturer.
- Re-layout and custom development services are available.

- Equipment used : Leo Bodnar Electronics Video Signal Input Lag Tester. Controller input port measured based on HDMI port and connect with a Innolux M280DGJ-L30 (3840x2160) panel.

APPENDIX I – SIGNAL SUPPORT MODE TABLE

HDMI input port (HDMI 2.0):

Resolution
640x480 60Hz
640x480 72Hz
640x480 75Hz
800x600 56Hz
800x600 60Hz
800x600 72Hz
800x600 75Hz
1024x768 60Hz
1024x768 70Hz
1024x768 75Hz
1280x768 60Hz
1280x768 75Hz
1280x800 60Hz
1280x800 75Hz
1280x1024 60Hz
1280x1024 75Hz
1360x768 60Hz
1366x768 60Hz
1440x900 75Hz
1600x1200 75Hz
1680x1050 75Hz
1920x1080 60Hz
1920x1200 60Hz
2560x1600 60Hz
3840x2160 23.976Hz
3840x2160 24Hz
3840x2160 25Hz
3840x2160 29.97Hz
3840x2160 30Hz
3840x2160 50Hz
3840x2160 59Hz
3840x2160 60Hz
4096x2160 23.976Hz
4096x2160 24Hz
4096x2160 25Hz
4096x2160 29.97Hz
4096x2160 30Hz
4096x2160 50Hz
4096x2160 59Hz
4096x2160 60Hz

Resolution
480p59.94
576p50
720p60
720p59.94
720p50
720p30
720p29.97
720p25
720p24
720p23.976
1080p60
1080p59.94
1080p50
1080p30
1080p29.97
1080p25
1080p24
1080p23.976

Display port input port (DP 1.2) :

Resolution
720x480 60Hz
720x576 50Hz
800x600 56Hz
800x600 60Hz
800x600 72Hz
800x600 75Hz
1024x768 60Hz
1024x768 70Hz
1024x768 75Hz
1280x768 60Hz
1280x800 60Hz
1280x1024 60Hz
1280x1024 75Hz
1366x768 60Hz
1400x1050 60Hz
1440x900 60Hz
1600x900 60Hz
1600x1200 60Hz
1680x1050 60Hz
1920x1080 60Hz
1920x1200 60Hz
2560x1600 60Hz
3840x2160 23.976Hz
3840x2160 24Hz
3840x2160 25Hz
3840x2160 29.97Hz
3840x2160 30Hz
3840x2160 50Hz
3840x2160 59Hz
3840x2160 60Hz
4096x2160 23.976Hz
4096x2160 24Hz
4096x2160 25Hz
4096x2160 29.97Hz
4096x2160 30Hz
4096x2160 50Hz
4096x2160 59Hz
4096x2160 60Hz

Resolution
480p59.94
576p50
720p60
720p59.94
720p50
720p30
720p29.97
720p25
720p24
720p23.976
1080p60
1080p59.94
1080p50
1080p30
1080p29.97
1080p25
1080p24
1080p23.976

Appendix II – RS-232 control protocols

RS-232 Serial control (Baud rate 9600, 8 bits, 1 stop bit and no parity)

Physical connection :

Controller side
Connector interface : CN8
Mating connector : Molex 51021-0600

Computer side
Connector interface : Serial port
Mating connector : DB9 Female

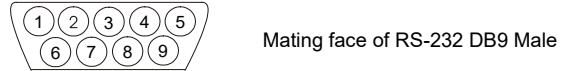

PIN#	Description
4	RS-232 Tx Data
5	Ground
6	RS-232 Rx Data

PIN#	Description
2	RS-232 Rx Data
3	RS-232 Tx Data
5	Ground

Remark :

(1) : RS-232 connection cable, 300mm P/N 426171800-3 can be ordered separately for connection.

Software connection :

The OSD function can be controlled through sending the RS-232 protocol.

The RS-232 program can be custom-made to fit for application or it can be used the serial control program, like Accessport, Telix or Serial Utility program developed by DigitalView. Please contact your local support for information.

1. Commands to implement switch mount control buttons

Function	Command	Description	Remark
Menu button	0xf7	Menu button pressed	Button equivalent
Select-down button	0xfa	Select-down button pressed	Button equivalent
Select-up button	0xfb	Select-up button pressed	Button equivalent
Right/+ button	0xfc	Right/+ button pressed	Button equivalent
Left/- button	0xfd	Left/- button pressed	Button equivalent

2. Parameter setting - immediate, relative, reset and query

Function	Command	Description	Acknowledge (if enabled)
Volume control - left+right channel	0x80, "a" "A", nn "+" "-" "r" "R" "?"	Set audio (L+R) volume = value/increment/decrement Reset Query	nn = 0x00~ 0x64 (0~100%) Default: 0x32 (50%)
Volume control - on/off (mute)	0x80, "m" "M", "0" "1" "r" "R" "?"	Disable audio output. Enable audio output. Reset Query	"0" - audio off (mute). "1" - audio on. (Default)
Black level control	0x81, nn "+" "-" "r" "R" "?" "m" "n" "i", ss, nn "o", ss,	Set brightness = value/increment/decrement Reset Query Current Source Maximum query Minimum query Set, Source, value Query, Source	nn = 0x00~ 0x64 (0~100%) Default: 0x32 (50%) ss- reference by Input main select(0x98)
Contrast control	0x82, "a" "A", nn "+" "-" "r" "R" "?" "m" "n" "i", ss, nn "o", ss,	Set all contrast = value/increment/decrement Reset Query Maximum query Minimum query Set, Source, value Query, Source	nn = 0x00~ 0x64 (0~100%) Default: 0x32 (50%) ss- reference by Input main select(0x98)
Saturation control	0x83, nn "+" "-" "r" "R" "?" "m" "n"	Set color saturation = value/increment/decrement Reset Query Maximum query Minimum query	nn = 0x00~ 0x64 (0~100%) Default: 0x32 (50%)
Hue control	0x84, nn "+" "-" "r" "R" "?" "m" "n"	Set tint = value/increment/decrement Reset Query Maximum query Minimum query	nn = 0x00~ 0x64 (0~100%) Default: 0x32 (50%)
Sharpness	0x8a, n "+" "-" "m" "n" "r" "R" "?"	Set sharpness = value/increment/decrement Maximum query *1 Minimum query *1 Reset Query	nn = 0x00~ 0x34 ("0"~"4") Default: 0x32 ("2")
Aspect Ratio	0x8c, "0" "1" "9" "A" "F"	Set graphic image scaling mode = Value	Image expansion on/off. "0" – 1:1. "1" – Full screen. "9" – 4:3

Specifications subject to change without notice

	"r" "R" "?"	Reset Query	"A" – 16:9 "F" – 5:4 (Default – "1")
Set display orientation	0x8e, n "r" "R" "?"	Set display orientation = value Reset Query	"0" – normal (default) "5" – 180 degree (Default – "0")
Set OSD Menu Rotate	0x8f, n "r" "R" "?"	Set OSD Menu orientation = value Reset Query	"0" – normal "1" – 270 degree "2" – 180 degree "3" – 90 degree (Default - "0")
OSD H position	0x90, nn "+" "-" "r" "R" "?"	Set OSD horizontal position = value/increment/decrement Reset Query	nn = 0x00~ 0x64 (left ~ right) Default: 0x32 (middle)
OSD V position	0x91, nn "+" "-" "r" "R" "?"	Set OSD vertical position = value/increment/decrement Reset Query	nn = 0x00~ 0x64 (top ~ bottom) Default: 0x32 (middle)
OSD transparency	0x92, nn "+" "-" "r" "R" "?"	Set OSD transparency = value/increment/decrement Reset Query	nn = 0x00~ 0x64 (0~100%) Default: 0x00 (No transparency)
OSD menu timeout	0x93, nn "+" "-" "r" "R" "?"	Select menu timeout = value/increment/decrement Reset Query	OSD menu timeout value. "ON" – Continuous. value – Round up to nearest available step. if value > max available step, set it to the max available step. "0x30 0x30" -- ON "0x30 0x42" – 11s " (default) up to "0x33 0x43" – 60s
Input main select	0x98, nn "+" "-" "r" "R" "?"	Select input main = HDMI or Display Port available Reset Query	"0x48,0x31" HDMI "0x50,0x31" Display Port (Default – Display Port)
Auto source seek	0x99, "0" "1" "r" "R" "?"	Set exclusive or priority = Off/On Reset Query	"0" – Off. "1" – On Default: "1" (On)
GAMMA value select	0x9d, n "r" "R" "?"	Select GAMMA value = Value Reset Query	"n": "5" – 1.8, "7" – 2.0, "2" – 2.2, (Default) "A" – 2.4 "C" – 2.6
Power Save	0x9f, "0" "1" "r" "R" "?"	Set power save option = On/Off Reset Query	"n": "0" – Power save off "1" – Power save on (Default)
Hot key 1 (plus and minus keys)	0xa0, "1", n	Set Hotkey 1= Value	"1" – Volume "2" – Backlevel (Brightness)

	"r" "R" "?"	Reset Query	"3" – Contrast "4" – Saturation "5" – Input source "B" – No function "E" – Aspect "G" – Hue "H" – Backlight Brightness "L" – Sharpness (Default – Volume)
Hot key 2 (up and down keys)	0xa0, "2", n "r" "R" "?"	Set Hotkey 2 = value Reset Query	"1" – Volume "2" – Backlevel (Brightness) "3" – Contrast "4" – Saturation "5" – Input source "B" – No function "E" – Aspect "G" – Hue "H" – Backlight Brightness "L" – Sharpness (Default – Input)
Runtime counter	0xa1, nnnnn "r" "R" "?"	Set runtime counter value = nnnnn (* 0.5 hour) Reset to zero Query	Runtime = nnnnn. Max. input = 0x1ffe (0x1ffe * 0.5 hour = 65535 hours) Runtime counter counts when backlight is on
Colour temperature select	0xb3, n "r" "R" "?" "i", ss, n "o", ss,	Select colour temperature = value Reset Query Set, Source, value Query, Source	"2" – 6500K. (Default) "4" – USER. "5" – 9300K "6" – 7500K "7" – 5800K. "8" – sRGB (Default – 6500K) ss - reference by Input main select(0x98).
Red level of User colour temperature	0xb4, nn "+" "-" "r" "R" "?" "m" "n" "i", ss, c, nn "o", ss, c,	Set the level of the red channel for the user colour temp. = value/increment/decrement Reset Query Maximum query Minimum query Set, Source, Temperature Group, value Query, Source	nn: 0x00~ 0xff (0~255) Default: 0x80 c – reference by Color Temperature ss - reference by Input main select(0x98).
Green level of User colour temperature	0xb5, nn "+" "-" "r" "R" "?" "m" "n"	Set the level of the green channel for the user colour temp. = value/increment/decrement Reset Query Maximum query Minimum query	nn: 0x00~ 0xff (0~255) Default: 0x80

	"i", ss, c, nn "o", ss, c	Set, Source, Temperature Group, value Query, Source	c – reference by Color Temperature ss - reference by Input main select(0x98).
Blue level of User colour temperature	0xb6, nn "+" "-" "r" "R" "?" "m" "n" "i", ss, c, nn "o", ss, c	Set the level of the blue channel for the user colour temp. = value/increment/decrement Reset Query Maximum query Minimum query Set, Source, Temperature Group, value *1 Query, Source *1	nn: 0x00~ 0xff (0~255) Default: 0x80 c – reference by Color Temperature ss - reference by Input main select(0x98).
Video horizontal resolution enquiry	0xb7	Horizontal resolution (in pixels) in 3 to 4 digit hex number	"nnn" = horizontal resolution
Video vertical resolution enquiry	0xb8	Vertical resolution (in lines) in 3 digit hex number	"nnn" = vertical resolution
Video horizontal sync frequency	0xb9	Horizontal sync frequency (in units of 100Hz) in 3 digit hex number	"nnn" = horizontal frequency
Video vertical sync frequency	0xba	Vertical sync frequency (in units of Hz) in 3 digit hex number and 1 char	"nnnc" = vertical frequency nnn = 3 digit hex c= "i" (interlace) or "p" (progressive)
OSD status enquiry	0xbb	Status of OSD	"0" – OSD turned off "1" – OSD turned on
OSD turn off	0xbd	Turn off the OSD.	"0" – fail. "1" – successful.
Backlight control	0xe0, nn "+" "-" "R" "r" "?"	Set Backlight level = value/increment/decrement Reset Query	nn = 0x00~ 0x64 (0~100%) Default: 0x64 (100%)
Backlight On/Off	0xe1, "0" "1" "R" "r" "?"	Backlight Off / Backlight On Reset Query	"0" – Backlight Off "1" – Backlight On. (Default) "?" – Query Backlight On/Off
Backlight DA/PWM	0xe5 "0" "1" "R" "r" "?"	Set backlight control method: PWM / DA Reset Query	"0" – PWM (Default) "1" – D/A
Backlight PWM frequency	0xe6, nnn "+" "-" "R" "r" "?"	Set backlight PWM frequency = value/increase 20Hz/decrease 20Hz Reset Query	Value 100Hz : "0", "6", "4" 120Hz : "0", "7", "8" 140Hz : "0", "8", "C" 160Hz : "0", "A", "0" (Default) 180Hz : "0", "B", "4" 200Hz : "0", "C", "8" 220Hz : "0", "D", "C" 240Hz : "0", "F", "0" 260Hz : "1", "0", "4" 280Hz : "1", "1", "8" 300Hz : "1", "2", "C" 320Hz : "1", "4", "0" 340Hz : "1", "5", "4" 360Hz : "1", "6", "8" 380Hz : "1", "7", "C" 400Hz : "1", "9", "0" 420Hz : "1", "A", "4" 440Hz : "1", "B", "8"
Backlight Invert	0xe7	Set invert backlight level :	"0" – Off (Default)

	<p>"0" "1" "R" "r" "?"</p>	<p>Off / On Reset Query</p>	<p>"1" – On</p>
Minimum backlight level	<p>0xee, "0x5C" nn "+" "-" "R" "r" "?"</p>	<p>Set minimum backlight level= value/increment/decrement Reset Query</p>	<p>Minimum Backlight value. nn: 0x00 ~ 0x32 (0~50%) Default: "0"5" (5%)</p>
OSD switch mount Lock	<p>"0xee", "0x62" "0" "1" "?"</p>	<p>Unlock / Lock Query</p>	<p>"0"- Unlock (Default) "1"- Lock, no response to OSD switch mount keys</p>
Default Power	<p>"0xee", "0x6B", "0x50" "0" "1" "?"</p>	<p>Default power state after supplying power to controller Off On Query</p>	<p>"0" - default power off "1" - default power on</p>
Query Light Sensor value	<p>0xee,0x70,0x50, 0x35 0x33,0x3F</p>	<p>Query value</p>	<p>e.g. 1735.7→ 0x36 0x43 0x37 0x2E 0x37)</p>
Query on board temperature sensor value	<p>0xee,0x70,0x50, 0x3B 0x34,0x3F</p>	<p>Query value</p>	<p>e.g. +25.5 → 0x2B 0x30 0x31 0x39 0x2E 0x35)</p>
Panel timing setting	<p>"0xee", "0x74",</p> <p>0x30, nnn 0x31, nnn 0x32, nnn 0x33, n 0x34, n 0x35, n </p> <p>0x36, nnnn 0x37, nnnn 0x38, nnnn 0x39, nnnn 0x3A, nnnn 0x3B, nnnn 0x3C, nnnn 0x3D, nnnn 0x3E, nnnn 0x3F, nnnn 0x40, nn 0x41, nn 0x42, nnn 0x43, nnn 0x44, nnn 0x45, nnnn 0x46, nnnn 0x47, nnnn 0x48, nnnn 0x49, nnnn 0x4A, nnnn </p> <p>0x4B</p>	<p>Panel timing setting</p> <p>0x30= typical frame rate 0x31= max frame rate 0x32= min frame rate 0x33= panel style 0x34= eDP phy rate 0x35=LVDS/Vx1 output ports</p> <p>0x36=Hsync back porch 0x37=Display horizontal width 0x38=Vertical total typical 0x39=Vertical total max 0x3A=Vertical total min 0x3B=Vsync back porch 0x3C=Display vertical height 0x3D=Horizontal total typical 0x3E=Horizontal total max 0x3F=Horizontal total min 0x40=Hsync width 0x41=Vsync height 0x42 = Pixel clock typical 0x43 = Pixel clock max 0x44 = Pixel clock min 0x45 = Panel power on time T1 0x46 = Panel power on time T2 0x47 = Panel power on time T3 0x48 = Panel power off time T4 0x49= Panel power off time T5 0x4A = Panel power off time T6</p> <p>Read all panel timing checksum</p>	<p>Set panel timing to SRAM of DT-4096. If cmd 2nd parameter is n = 0x3F, it dumps the values of SRAM Please note "n" is BCD decimal value in ASCII. e.g. 610 is set as 0x36 0x31 0x30</p> <p>4=Vx1, 5=eDP1.2 0=RBR, 1=HBR, 2=HBR2 0=1ports,1=2ports,2=4ports,3=8ports (default)</p> <p>in MHz in MHz in MHz in ms in ms in ms in ms in ms in ms in ms in ms in ms in ms in ms in ms in ms in ms in ms in ms in ms in ms in ms</p> <p>checksum, which is found by adding values of parameter 0x30 to 0x4A</p>

	0x4C	Read all panel timing parameter	Read all parameters from SRAM and dump each timing starting with 0xEE 0x74 0xYY nnnn to facilitate saving dump data to file for send back to DT-4096 later
	0x4D, n	0x4D Output Display Bit Mode	1-8bit, 2-10bit
	0x4E, n	0x4E Panel Display Division	1 - 1 division (no division) 2 - 2 division 4 - 4 division 8 - 8 division
	0x57	Write all panel timing parameters from SRAM into EEPROM	"1": Success "0": Fail
User EDID	"0xee", "0x76", "nn",	Command Select Port	"nn" = "0x50, 0x31": DP "0x48, 0x31": HDMI
EDID Block map for blocks 0 – 128	"S" "s" "n,n+1....(256 BYTE) "	Send 128 BYTE EDID in ASCII Code Format (256BYTE)	return "1" Success return "0" Fail
EDID Block map for blocks 129 – 254 if more than 128 blocks used	"E" "e" "n,n+1....(256 BYTE) "	Send 128 BYTE EDID in ASCII Code Format (256BYTE)	return "1" Success return "0" Fail
Reset	"R" "r"	Reset to use pre-defined EDID instead of user EDID of selected port	return "1" Success return "0" Fail
Light Sensor Setting	0xee,0x78 "0x30", "n" "0x31", "nnn" "0x32", "nnn" "0x33", "nnn" "0x34", "nnn" "0x35", "nnn" "0x36", "nnn" "0x37", "nnn" "0x38", "nnn" "0x39", "nnn" "0x3A", "nnn" "0x3B", "nnn" "0x3C", "nnn" "0x3D", "nnn" "0x3E", "nnn" "0x3F", "nnn" "0x40", "nnn" "0x41", "nnn" "0x42", "nnn" "0x43", "nnn"	Light Sensor Settings 0x30 = Light Sensor Mode 0x31 = Level 1 value 0x32 = Level 2 value 0x33 = Level 3 value 0x34 = Level 4 value 0x35 = Level 5 value 0x36 = Level 6 value 0x37 = Level 7 value 0x38 = Level 8 value 0x39 = Level 9 value 0x3A = Level 10 value 0x3B = Level 11 value 0x3C = Level 12 value 0x3D = Backlight 1 value 0x3E = Backlight 2 value 0x3F = Backlight 3 value 0x40 = Backlight 4 value 0x41 = Backlight 5 value 0x42 = Backlight 6 value 0x43 = Backlight 7 value	n = "0x30": Disable, "0x31": Enable, nnn = 0 ~ 1800 : 0x30,0x30,0x30 ~ 0x37,0x30,0x38 nnn = 0 ~ 100 : 0x30,0x30,0x30 ~ 0x30,0x36,0x34 Or nnn = 0 ~ 255: 0x30,0x30,0x30 ~ 0x30,0x46,0x46 nnn = OFF: 0x45,0x45,0x45

	"0x44", "nnn" "0x45", "nnn" "0x46", "nnn" "0x47", "nnn" "0x48", "nnn" 0x3F "0x57" **	0x44 = Backlight 8 value 0x45 = Backlight 9 value 0x46 = Backlight 10 value 0x47 = Backlight 11 value 0x48 = Backlight 12 value Query Write all light sensor parameters from SRAM into EEPROM	"0x31": Success "0x30": Fail
--	--	---	---------------------------------

3. Other control

Function	Command	Description	Acknowledge (if enabled)
Select RS-232 acknowledge	0xc1, "0" "1"	Disable/enable command acknowledge.	"0" – acknowledge disabled. "1" – acknowledge enabled. (Default)
Command availability	0xc4, nn / nnnn	Check whether a command is available.	"0" – not available. "1" – available. e.g "0x81" command send "0xc4 0x38 0x31" feedback "0xc4 0x38 0x31 0x31"
Power On/Off	0xc8, "0" "1" "?"	Soft power on/off off/on query	"0" – soft power off. "1" – soft power on.
Query video input status	0xc9	Query the status of the displaying video windows source	Input status nn nn: "0", "0" : Invalid / No video source "H,"1" : HDMI "P,"1" : DP
Query BIOS version	0xcb, "0"	Read BIOS version	BIOS version "VV.YY.ZZ" VV = Vx or Ex, (x is version digit) V = Release version E = Engineering Sample YY= Version Number ZZ= Customer Number
Query PCBA number	0xcb, "1"	Read PCBA number	"nnnn" = PCBA number DT-4096= "41782"
Query Revision Number	0xcb, "3"	Read Revision Number	"nn" = Revision number AA in firmware version no. "VV.YY.ZZ.AA"
Test Pattern	0xcd, "0" "1" "2" "3" "4" "5" "6" "7" "8"	Off Pattern: Red Green Blue White Black ColorBar SMPTEColor Bar 8 Bit GreyBar	n: action value
Reset parameters	0xce	Reset all parameters to default value	"1" – successful.
Reset all parameters	0xcf	Reset all parameters, including user color temperature setting, for all video modes to default value	"1" - successful.
CopyRight	0xf8, "C"	Command Read CopyRight	return "DIGITALVIEW LTD."

n = 1-byte ascii-coded hex number, e.g., parameter value of 0x1 is represented by "1" (0x31).
mn or nn = 2-byte ascii-coded hex number, e.g., parameter value of 0x1e is represented by "1", "e" | "E" (0x31, 0x6e|0x4e).

The RS-232 command strings sent in one time can support up to 380 bytes via CN8 port
The RS-232 command string sent in one time can support up to 50 bytes via J1 port.

n = 1-byte ascii-coded hex number, e.g., parameter value of 0x1 is represented by "1" (0x31).
mn or nn = 2-byte ascii-coded hex number, e.g., parameter value of 0x1e is represented by "1", "e" | "E" (0x31, 0x6e|0x4e).

Please refer to the ASCII to Hex convert table below.

Hex to ASCII conversion table

Hex	ASCII	Hex	ASCII	Hex	ASCII	Hex	ASCII
0x30	0	0x41	A	0x61	a	0x2B	+
0x31	1	0x42	B	0x62	b	0x2D	-
0x32	2	0x43	C	0x63	c	0x3F	?
0x33	3	0x44	D	0x64	d		
0x34	4	0x45	E	0x65	e		
0x35	5	0x46	F	0x66	f		
0x36	6	0x47	G	0x67	g		
0x37	7	0x48	H	0x68	h		
0x38	8	0x49	I	0x69	i		
0x39	9	0x4A	J	0x6A	j		
		0x4B	K	0x6B	k		
		0x4C	L	0x6C	l		
		0x4D	M	0x6D	m		
		0x4E	N	0x6E	n		
		0x4F	O	0x6F	o		
		0x50	P	0x70	p		
		0x51	Q	0x71	q		
		0x52	R	0x72	r		
		0x53	S	0x73	s		
		0x54	T	0x74	t		
		0x55	U	0x75	u		
		0x56	V	0x76	v		
		0x57	W	0x77	w		
		0x58	X	0x78	x		
		0x59	Y	0x79	y		
		0x5A	Z	0x7A	z		

Appendix III – DDC/CI support at HDMI & Display port

This controller supports the following DDC/CI functions at HDMI & Display port :

- Brightness (Backlight brightness)
- Contrast
- Color Temperature (6500K/7500K/9300K/sRGB/User)
- Sharpness
- Input Source (HDMI & Displayport)
- Power mode (Power on/off)
- Restore factory defaults (exclude user color temperature, brightness)
- Volume

Appendix IV – DV remote control unit work for DT-4096

P/N 5590001xx-3 :
DigitalView remote control unit
(without DV logo silk screen
printing)



BUTTON	FUNCTION
POWER BUTTON	Soft power ON/OFF button.
SEL UP (^) / SEL DN (v)	1. In OSD menu, pressing "SEL UP" button to move previous level of selection. 2. In OSD menu, pressing "SEL DN" button to move next level of selection or to CONFIRM the selection.
+ BUTTON	When OSD menu displayed, press this button to select functions (forward) or increase the values.
- BUTTON	When OSD menu displayed, press this button to select functions (backward) or decrease the values.
AV/TV BUTTON	Use to select the input source. (/HDMI/Displayport)
OSD NEXT BUTTON	Use to turn on/off the OSD menu.
Mute	Mute / Un-mute audio

Appendix V – Light Sensor Function work for DT-4096

DT-4096 provides an interface to enable automatic backlight adjustment. It is possible to connect with a light sensor directly to the controller board.

Use of the light sensor board P/N 416021310/416021330-3 and light sensor cable P/N 426305900-3 connect to the DT-4096 via CN6 connector or use the light sensor cable P/N 426321940-3 as shown below :

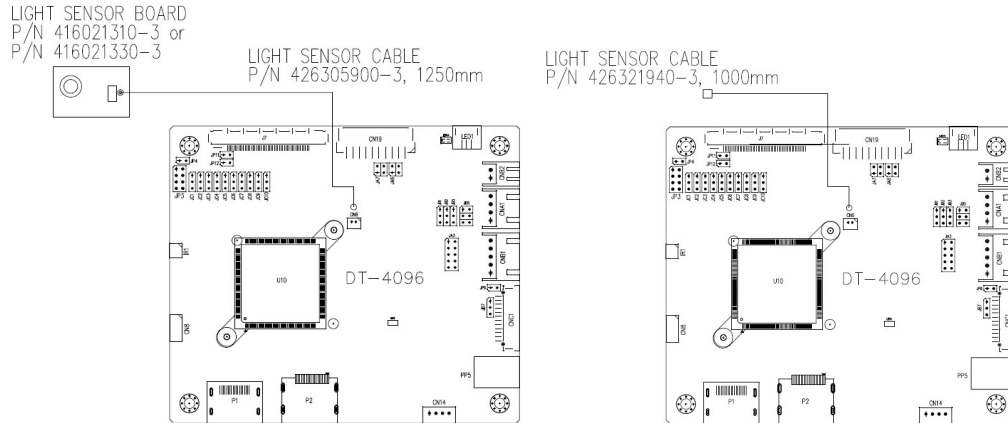

Digital View provides a user-friendly software program (TCP/IP Serial Utility V1.14 or later revision) can set thresholds for ambient light and the LCD panel backlight adjustment.

The settings can be Open/Save as by file.

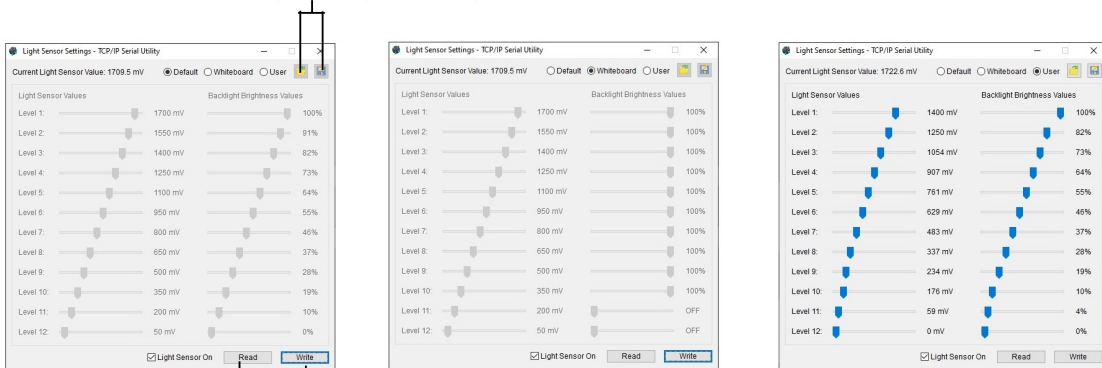

Read the current settings from controller

Confirm to write the current settings onto controller

Three auto dimming modes:

- Default - All the dimming level are preset as linear backlight %.
- Whiteboard - When room light 'ON', set backlight 100%, otherwise 'OFF' the backlight.
- User - Only this mode can be user configurable.

When designing a monitor a light sensor can be placed in a suitable location to detect changes in lighting and adjust the LCD panel backlight brightness appropriately.

WARRANTY

The products are warranted against defects in workmanship and material for a period of three (3) year from the date of purchase provided no modifications are made to it and it is operated under normal conditions and in compliance with the instruction manual.

The warranty does not apply to:

- Product that has been installed incorrectly, this specifically includes but is not limited to cases where electrical short circuit is caused.
- Product that has been altered or repaired except by the manufacturer (or with the manufacturer's consent).
- Product that has subjected to misuse, accidents, abuse, negligence or unusual stress whether physical or electrical.
- Ordinary wear and tear.

Except for the above express warranties, the manufacturer disclaims all warranties on products furnished hereunder, including all implied warranties of merchantability and fitness for a particular application or purpose. The stated express warranties are in lieu of all obligations or liabilities on the part of the manufacturer for damages, including but not limited to special, indirect consequential damages arising out of or in connection with the use of or performance of the products.

CAUTION

Whilst care has been taken to provide as much detail as possible for use of this product it cannot be relied upon as an exhaustive source of information. This product is for use by suitably qualified persons who understand the nature of the work they are doing and are able to take suitable precautions and design and produce a product that is safe and meets regulatory requirements.

LIMITATION OF LIABILITY

The manufacturer's liability for damages to customer or others resulting from the use of any product supplied hereunder shall in no event exceed the purchase price of said product.

TRADEMARKS

The following are trademarks of Digital View Ltd:

- Digital View
- DT-4096

CONTACT DETAILS

Digital View has offices in Asia, Europe and USA :

USA

Digital View Inc.
18440 Technology Drive
Building 130
Morgan Hill,
California, 95037
USA

Tel: (1) 408-782 7773 **Fax:** (1) 408-782 7883

Sales: ussales@digitalview.com

EUROPE

Digital View Ltd.
The Lake House
Knebworth Park
Herts, SG3 6PY
UK

Tel: +44-(0)20-7631-2150 **Fax:** +44-(0)20-7631-2156

Sales: uksales@digitalview.com

ASIA

Digital View Ltd
Units 705-708, 7/F Texwood Plaza
6 How Ming Street
Kwun Tong
Hong Kong

Tel: (852) 2861 3615 **Fax:** (852) 2520 2987

Sales: hksales@digitalview.com

WEBSITE

www.digitalview.com

Revision History

Date	Rev No.	Page	Summary
8 April 2022	1.00	All	First issued
27 April 2022	1.10	8	Correct Hot Key 1 & 2 function item
5 Jan 2023	1.20	4	Remove point 15 for 'Reserved for Audio adaptor board P/N 416940020-3'
30 Jan 2023	1.30	8 16	- Correct default hotkey 1 & 2 (default hotkey 1 to 'Brightness' and default hotkey 2 to 'Input'). - Correct J7 connector pin definition.
23 May 2023	1.40	17	- Revised P2 (Display Port input) connector pin assignment.
21 Aug 2023	1.50	8	- Remove '3200' color temperature setting in the OSD menu under 'Color' > 'Temperature' page.
9 Nov 2023	1.60	14	- Assign JP3 to 1-2 closed for supporting AU Optronics G270ZAN01.1 panel.