



DVI, DISPLAY PORT, HDMI, VIDEO INTERFACE CONTROLLER FOR TFT PANEL

Model: HX-4096

Part number : 41755012X-3 or up

INSTRUCTIONS

CONTENTS

Page:	2. Introduction, How to Proceed, Usage Note, Disclaimer
	3. System design – Diagram of a suggested system
	5. Assembly notes – Important information about system elements
	7. Connection & Operation – How to use the controller
	13. Connectors, pinouts & jumpers – Essential connection information
	30. Controller dimensions
	31. Application notes
	33. Troubleshooting
	34. Specifications
	36. Appendix I – Signal support modes table
	40. Appendix II – Network connection
	43. Appendix III – RS-232 control protocols and command set
	53. Appendix IV - Mapping definition
	55. Appendix V – DV remote control unit work for HX-4096
	56. Appendix VI - PIP mix table
	57. Appendix VII – Functions list on browser page
	60. Warranty, Caution & Limitation of Liability, Trademarks
	61. Contact details
	62. Revision History

It is essential that these instructions are read and understood before connecting or powering up this controller.

Introduction

Designed for LCD monitor and other flat panel display applications, the HX-4096 is a feature rich interface controller for :

- **TFT (active matrix) LCD panels of 4096x2160 resolutions in 60Hz with V-by-One, eDP or LVDS interface.**
- **Support true 10 bits panel**
- **Support HDMI, DVI and Display Port input.**

HOW TO PROCEED

- Ensure you have all parts & that they are correct, refer to:
 - Connection diagram

Controller Solution Generator

Full web resource matching controllers & panels with **connection diagrams** for download.
See at : <http://www.digitalview.com/csg>

- Connector reference (in following section)
- Assembly notes
- Check controller switch & jumper settings (errors may damage the panel)
- Prepare the signal sources
- Connect the parts
- Understand the operation & functions

IMPORTANT USAGE NOTE

This equipment is for use by developers and integrators, the manufacturer accepts no liability for damage or injury caused by the use of this product. It is the responsibility of the developer, integrators or other user of this product to:

- Ensure that all necessary and appropriate safety measures are taken.
- Obtain suitable regulatory approvals as may be required.
- **Check power settings to all component parts before connection.**

DISCLAIMER

There is no implied or expressed warranty regarding this material.

SYSTEM DESIGN

A typical LCD based display system utilizing this controller is likely to comprise the following:

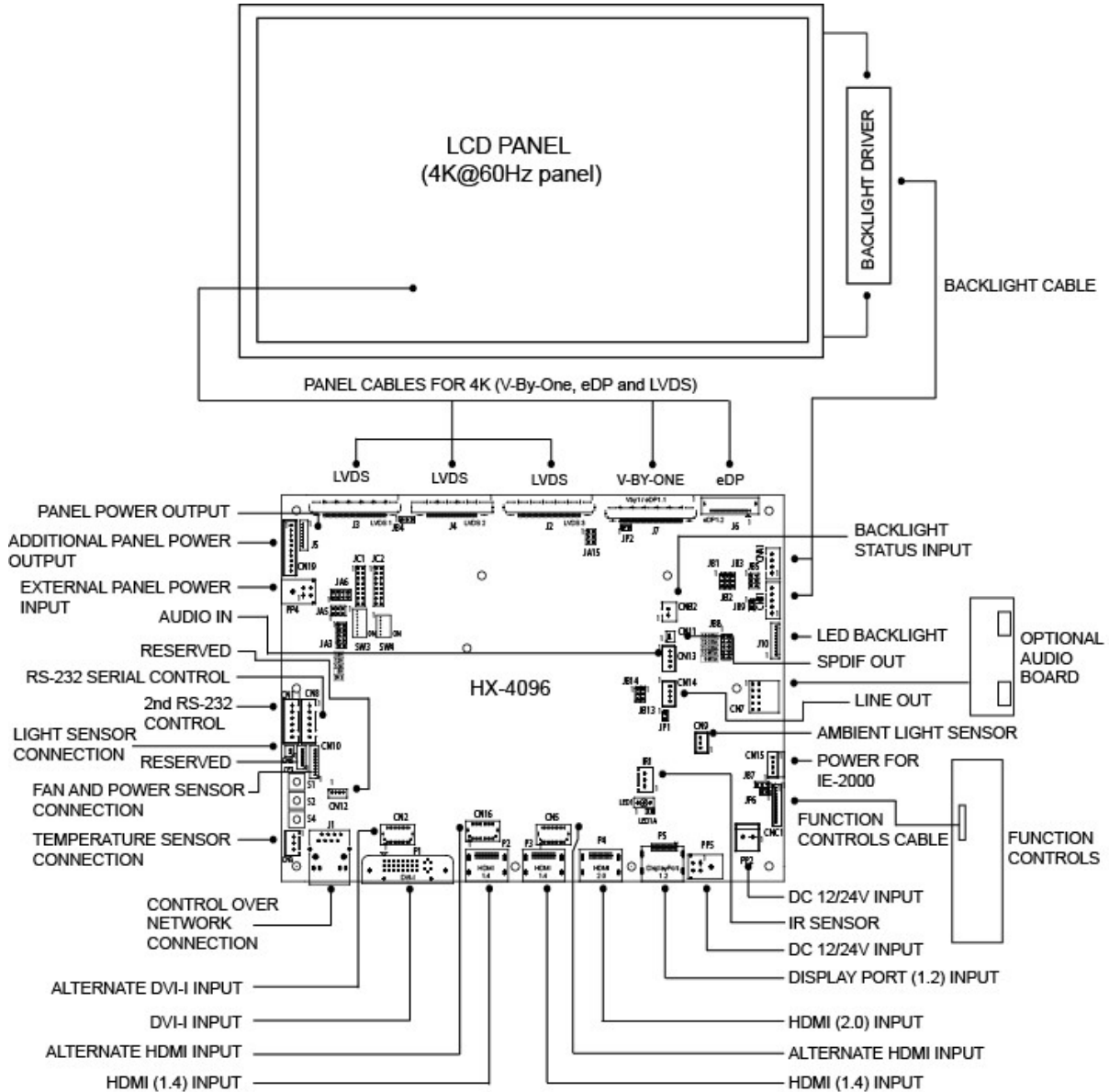

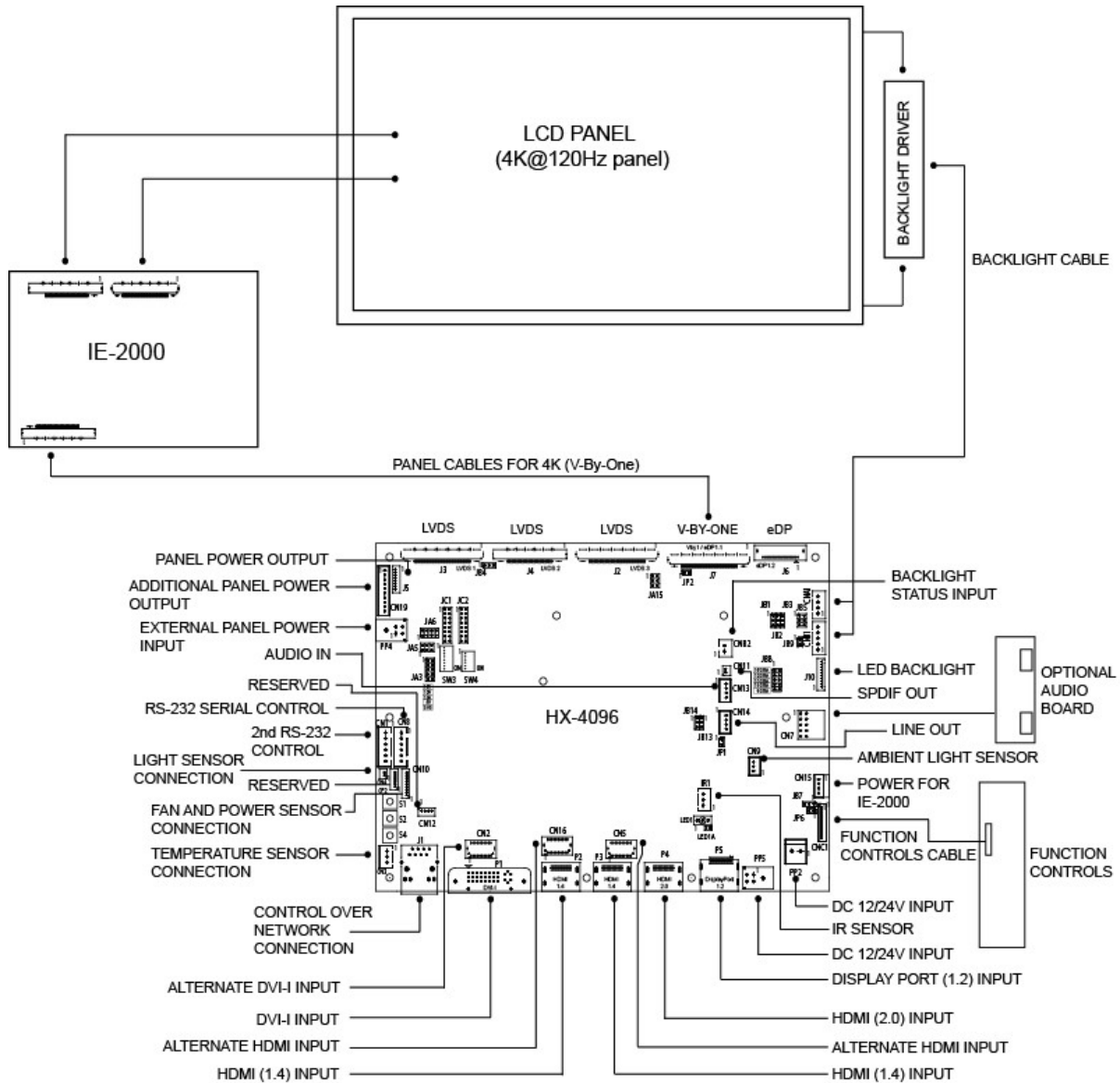

ASSEMBLY NOTES

This controller is designed for monitor and custom display projects using 4096x2160 resolution with V-by-One interface, eDP interface or LVDS TFT panels. The following provides some guidelines for installation and preparation of a finished display solution.

Preparation: Before proceeding it is important to familiarize yourself with the parts making up the system and the various connectors, mounting holes and general layout of the controller. As much as possible connectors have been labeled. Guides to connectors and mounting holes are shown in the following relevant sections.

1. **LCD Panel:** This controller is designed for typical V-by-One (8 lanes), eDP (HBR/HBR2) and LVDS interfaced panels with panel voltage 3.3V(4A), 5V(4A), 10V(4A), 12V(4A) or 18V(3A), External for 10V, 12V and 18V interface. Due to the variation between manufacturers of panels signal timing and other panel characteristics, factory setup and confirmation should be obtained before connecting to a panel. **(NOTE: Check panel power jumper settings before connection)**
2. **LCD Controller:** Handle the controller with care as static charge may damage electronic components. Make sure correct jumper to match the target LCD panel.
3. **Panel cable:** In order to provide a clean signal it is recommended that all panel cables (V-by-One signal, eDP and LVDS) supplied by Digital View. Care should be taken when placing the cables to avoid signal interference.
4. **Inverter/Backlight driver:** This will be required for the backlight of an LCD, some LCD panels have an inverter/backlight driver built in. As LCD panels may have 1 or more backlight tubes and the power requirements for different panel backlights may vary it is important to match the inverter/backlight driver in order to obtain optimum performance. See Application notes page 31 for more information on connection.
5. **Inverter/backlight cables:** Different inverter/backlight models require different cables and different pin assignment. Make sure correct cable pin out to match the inverter/backlight. Using wrong cable pin out may damage the inverter/backlight.
6. **Function Controls:** The following section discusses the controls required and the section on connectors provides the detail. The controls are minimal: On/Off, Backlight Brightness (depends on inverter), OSD (5 momentary buttons) analog VR type or (8 momentary buttons) digital type.
7. **Function controls cable:** The cables to the function switches should be of suitable quality and length so that impedance does not affect performance. Generally lengths up to 1 meter (3 feet) should be acceptable.
8. **Optional LED:** The pin direction of the LED should be corrected for right color indication. Red color stands for standby. Green colors stands for signal on. The status LED is an optional part only, can be unconnected.
9. **Optional IR sensor:** It is an optional part only, can be unconnected if not using IR remote control.
10. **RS-232 control interface :** Serial control via this interface port.
11. **External panel power output :** User for specific panel model.
12. **Panel control signal :** Use for specific panel model.
13. **SPDIF Audio output :** This port support SPDIF audio output from the HDMI / Display Port audio source inputted.
14. **Ambient light sensor connection :** 3 ways connector provides interface for ambient light sensor connection by using Kit 70220-3.
15. **Backlight status input :** 2 ways connector provides interface for connection with the specific panel type which support the panel with backlight status monitoring function.
16. **On board LED backlight driver :** The on board LED driver supports 4 LED strings max 50V total LED backlight via J10 connector.
17. **DVI-I input cable :** Plug the DVI cable to the connector P1 on the controller board.
18. **HDMI input :** Plug the HDMI cable to the connector P2(HDMI 1.4) / P3(HDMI 1.4) / P4(HDMI 2.0) on the controller board. This port is not supported when CN5/CN16 are connected.
19. **Alternate HDMI input :** This port gives alternate HDMI input support.
20. **Alternate DVI-I input :** This port gives alternate DVI-I input support.
21. **Control over network connection :** This is a network device that allow to control RS-232 enable devices over a TCP/IP based Ethernet and the Internet using a web browser. Please refer to Appendix V in details.
22. **Reserved for Audio adaptor board P/N 416940020-3:** The audio add-on board gives the audio input and output signal connection. It is an optional and reserved part only, can be unconnected if not using audio. It requires an audio cable P/N 426451800-3 to connect HX-4096 (CN14) to the Audio Add-on Board (CN2).
CAUTION : The Audio Add-on Board P/N 416940020-3 can only operate with 12VDC power input environment.

Specifications subject to change without notice

23. **Reserved for Audio extend cable** : The audio extend cable P/N 426009700-3 designs for connection between audio add on board P/N 416940020-3 and the controller. It is an optional and reserved part only, can be unconnected if not using audio.
24. **Additional panel power input** : Provide additional (+10V/+12V/+18V) panel power input for driving high power consumption panels.
25. **Power Input**: 12V/24VDC is required, this should be a regulated supply. It allows 12V (5A) or 24V (5A) via PP5 power input connector. The power rating is depending on the panel and inverter used. Although the controller provides power regulation for the LCD power this does not relate to the power supplied to the backlight inverter.
If an unregulated power supply is provided to an inverter any fluctuations in power may affect operation, performance and lifetime of the inverter and or backlight tubes.
26. **External panel power input** : Allow to supply external power to the panel separately for max 3.3V (7A) or 5V (7A) or 10V (5A) or 12V (5A) or 18V (3.5A) via PP4 power input connector. Corresponding jumper setting of JA3, JA5 & JA6 are required for each panel power input by referring to page 16.
- **Power output**: Note the controller has an overall 3Amp current limit and the current available from the auxiliary power output will be dependent on the power input and other system requirements.
 - **Power Safety**: Note that although only 12V / 24VDC is required as 'power-in' a backlight inverter for panel backlighting produces significantly higher voltages (the inverter does not connect to the ground plane). We strongly advise appropriate insulation for all circuitry.
 - **EMI**: Shielding will be required for passing certain regulatory emissions tests. Also the choice of external Controller to PC signal cable can affect the result.
 - **Ground**: The various PCB mounting holes are connected to the ground plane.
 - **Servicing**: The board is not user serviceable or repairable. Warranty does not cover user error in connecting up to the controller and is invalidated by unauthorized modification or repairs.
 - **Controller Mounting**: It is recommended that a clearance of at least 10mm is provided above and 5mm below the controller when mounted. Additionally consideration should be given to:
 - Electrical insulation.
 - Grounding.
 - EMI shielding.
 - Cable management. Note: It is important to keep panel signal cables apart from the inverter & backlight cables to prevent signal interference.
 - Heat & Ventilation: Heat generated from other sources, for example the backlight of a very high brightness panel may generate significant heat which could adversely affect the controller.
 - Other issues that may affect safety or performance.
 - **PC Graphics Output**: A few guidelines:
 - Signal quality is very important, if there is noise or instability in the PC graphics output this may result in visible noise on the display.
 - Refer to graphics modes table in specifications section for supported modes.
 - Non-interlaced & interlaced video input is acceptable.

IMPORTANT: Please read the Application Notes section for more information.

CONNECTION & OPERATION

CAUTION: Never connect or disconnect parts of the display system when the system is powered up as this may cause serious damage.

CONNECTION

Connection and usage is quite straight forward (it is useful to have the relevant connection diagram available at this time):

1. **LCD panel & Inverter:** Connect the inverter/Backlight driver (if it is not built-in the panel) to the inverter/backlight connector of the LCD panel.
2. **V-by-One interface panels:** The controller board supports V-by-One interface 4K panel. Plug the cable to J7 for driving 4K 60Hz panel. And make sure the matching panel timings and correct jumper settings (JB13 & JB14) by referring to the panel support table and jumper settings table in page 13-16.
3. **eDP interface panels:** The controller board supports eDP(1.1) or eDP(1.2) interface 4K panel. For eDP(1.1) panel, plug the cable to J7. For eDP(1.2) panel, plug the cable to J6. And make sure the matching panel timings and correct jumper settings (JB13 & JB14) by referring to the panel support table and jumper settings table in page 13-16.
4. **LVDS interface panels:** The controller board supports LVDS interface 4K panel. Plug the cable to J2/J3/J4 for driving 4K 60Hz panel. And make sure the matching panel timings and correct jumper settings (JB13 & JB14) by referring to the panel support table and jumper settings table in page 13-16.
5. **Inverter/Backlight driver:** Plug the inverter/backlight cable to CNB1 and CNA1 (if necessary). Plug another end to the connector on the inverter/backlight of panel side.
6. **Function switch & Controller:** Plug the OSD switch mount cable to CNC1 on the controller board and another to the OSD switch mount.
7. **LED & Controller:** Plug in a 3-way with dual color LED to connector LED1 on the controller board.
8. **IR & Controller:** Plug in a 3-way with IR sensor to connector IR1 on the controller board.
9. **Jumpers & Inverter & Panel voltage:** Particularly pay attention to the settings of JA3, JA5, JA6, JB2 and JB3. JB2 & JB3 are used for inverter control (read inverter specification and information on the jumper table to define the correct settings). JA3 & JA5 & JA6 is used for panel voltage input (read panel specification and information on the jumper table to define the correct settings).
10. **Input signal cable & Controller:** Plug the corresponding signal input to the connector on the controller board.
11. **Power supply & Controller:** Plug the DC 12V/24V power in to the connector PP2 or PP5. You can consider to use DigitalView mating power cable P/N 426013710-3, 1000mm for PP5 connection.
12. **External panel power input :** Plug power cable : P/N 426013710-3 for external panel power input (3.3 (max 7A) / 5V (max 7A) / 10V (max. 5A) / 12V (max 5A) / 18V (max3.5)) for PP4 connection.
13. **Power on:** Switch on the controller board and panel by using the OSD switch mount.

General:

- If you are using supplied cables & accessories, ensure they are correct for the model of panel and controller.
- If you are making your own cables & connectors refer carefully to both the panel & inverter specifications and the section in this manual, "Connectors, Pinouts & Jumpers" to ensure the correct pin to pin wiring.

PC SETTINGS

The controller has been designed to take a very wide range of input signals however to optimize the PC's graphics performance we recommend choosing 60Hz vertical refresh rate – this will not cause screen flicker.

OPERATION

Once the system has been connected and switched on there are a number of functions available to adjust the display image as summarized in the following sections. The settings chosen will be saved for each mode independently.

LCD DISPLAY SYSTEM SETTINGS

NOTE: By way of explanation the following refers to a set of sample buttons that may be obtained as an option. In addition to power on/off and connection for backlight brightness the controller provides an On Screen Display of certain functions which are controlled by 5 momentary type buttons (analog VR type) or 8 momentary type buttons (digital type):

Controls	Analog VR type	Digital type
On/Off – turns controller board power on	VR toggle switch	On/Off button
Brightness – controls backlight brightness	Rotary VR	Brightness +/- buttons
Menu • Turns OSD menu On or Off (it will auto time off)	Menu button	Menu button
Select up • Moves the selector to the previous level function (up)	SEL UP	SEL UP
Select down • Moves the selector to the next level function (down) • Confirm the OSD selection	SEL DN	SEL DN
+ • Increase the OSD parameter values • Moves the selector to next function (forward)	+	+
- • Decrease the OSD parameter values • Moves the selector to previous function (backward)	-	-

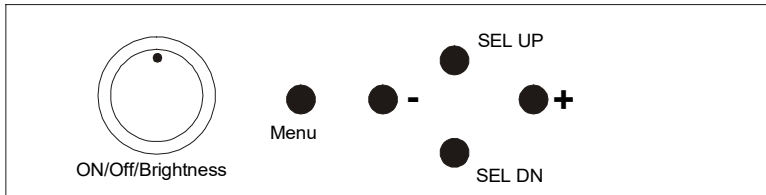

Analog VR type

12V / 24VDC power input :
Analog 10K VR Type OSD switch mount uses
P/N 410680550-3 or up

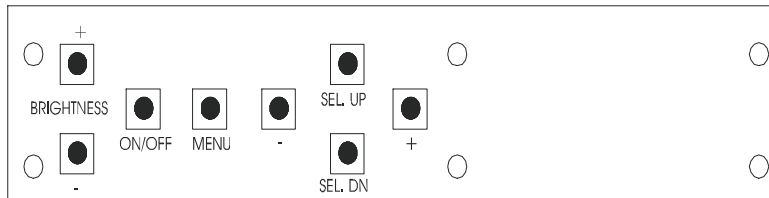





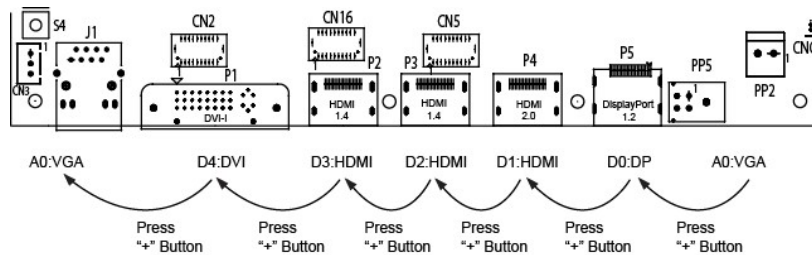

Digital type

12V / 24VDC power input :
Digital 10K Type OSD switch mount uses
P/N 416100520-3 or up

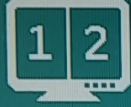
* Sequence of Input source selection (Press "+" Button to change source, Press "SEL DN" to confirm)

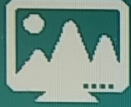

OSD functions

 <p>Display Mode</p>	<p>Display Mode:</p>  <p>[Default]</p>
 <p>Display Function</p>	<p>Display Function:</p> <p>1P: Disp Rotate : 0 [Default] 90 180 270</p> <p>2P LR: Input Swap</p> <p>2P TB: Input Swap</p> <p>2P PIP: PIP Position : Top-left Top-right Bottom-left Bottom-right [Default]</p> <p>PIP Transparency : [0 - 10] [Default 0] PIP Size : [0 - 10] [Default 10] Input Swap</p>
 <p>Picture</p>	<p>Picture:</p> <p>Backlight [0-100] [Default 100] Brightness [0-100] [Default 50] Contrast [0-100] [Default 50] Sharpness [0-4] [Default 2]</p>
 <p>VGA Setup</p>	<p>VGA Setup:</p> <p>Auto Adjust H Position [0-100] [Default 50] V Position [0-100] [Default 50] Clock [0-100] [Default 50] Phase [0-100] [Default 0]</p> <p>Color Gain : Set Reset</p>
 <p>Color</p>	<p>Color:</p> <p>Gamma : 1.8 2.0 2.2 [Default] 2.4</p> <p>Temperature: 9300 7500 6500 [Default] 5800 3200 sRGB User : R [0-255] G [0-255] B [0-255]</p> <p>Color Effect: Standard [Default] Game Movie Photo Vivid</p>

User: R:
 Hue [0-100]
 Sat [0-100]
 Y:
 Hue [0-100]
 Sat [0-100]
 G:
 Hue [0-100]
 Sat [0-100]
 C:
 Hue [0-100]
 Sat [0-100]
 B:
 Hue [0-100]
 Sat [0-100]
 M:
 Hue [0-100]
 Sat [0-100]

Hue: [0-100] [Default 50]
 Saturation [0-100] [Default 50]

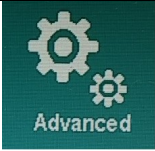

Advanced:

Aspect Ratio: Full [Default]
 16:9
 4:3
 5:4
 1:1

Over Scan: ON [Default]
 OFF



Over Drive: ONOFF: ON
 OFF [Default]
 OD Gain [0-100] [Default 50]

Communication: RS-232 [Default]
 Network

Auto Source Seek: OFF
 ON [Default]

Hot Key: Hot Key 1 (< | >) : Input
 Backlight
 Brightness
 Contrast
 Sharpness
 Hue
 Saturation
 Aspect Ratio
 Display Mode
 Input Swap
 PIP Size
 Auto Adjust
 Volume
 No Function [Default]

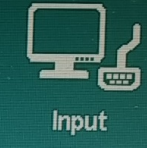
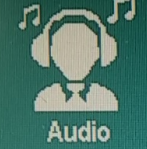
Hot Key: Hot Key 1 (Up | Dn) : Input
 Backlight
 Brightness
 Contrast
 Sharpness
 Hue
 Saturation
 Aspect Ratio
 Display Mode
 Input Swap
 PIP Size
 Auto Adjust
 Volume
 No Function [Default]

	<p>Power Save: OFF ON [Default]</p> <p>Default Power: OFF ON [Default]</p>
 <p>Input</p>	<p>Input: (For all display modes: 1P/ 2R LR / 2P TB / 2P PIP / 4P)</p> <p>A0 : VGA D0 : DP D1 : HDMI D2 : HDMI D3 : HDMI D4 : DVI</p>
 <p>Audio</p>	<p>Audio:</p> <p>Volume [0-100] [Default 50]</p> <p>Mute: ON OFF [Default]</p> <p>Audio Source (1P) : Analog [Default] Digital (region 1)</p> <p>Audio Source (2P LR) : Analog [Default] Digital (region 1) - Left Digital (region 2) - Right</p> <p>Audio Source (2P TB) : Analog [Default] Digital (region 1) - Top Digital (region 2) - Bottom</p> <p>Audio Source (2P PIP) : Analog [Default] Digital (region 1) - Main Digital (region 2) - Sub</p> <p>Audio Source (4P) : Analog [Default] Digital (region 1) - Upper left Digital (region 2) - Lower left Digital (region 3) - Upper right Digital (region 4) - Lower right</p>
 <p>Other</p>	<p>Other:</p> <p>Reset</p> <p>Menu Time [On, 11-60] [Default 11]</p> <p>OSD H Position [0-100] [Default 50]</p> <p>OSD V Position [0-100] [Default 50]</p> <p>Language</p> <p>Transparency [0-255] [Default 0]</p> <p>Rotate: 0 [Default 0] 90 270</p> <p>Border Width: [0-10] [Default 0]</p> <p>Border Color: R [Default] G B W</p>



Information:

D: HDMI
3840x2160@60.1Hz
H:135.1KHz PCLK: 594.4MHz
HDCP Disabled



Factory:

**Backlight Setup: Invert : OFF [Default]
ON**

**D/A / PWM : PWM [Default]
D/A**

Frequency : [100Hz - 440Hz] [Default 160Hz]

Min. Level : [0% - 50%] [Default 5%]

**VBy1 Setup : Pin 15 : Low [Default]
High**

**Pin 16 : Low [Default]
High**

**Pin 17 : Low [Default]
High**

**Pin 18 : Low [Default]
High**

**Pin 19 : Low [Default]
High**

**Pin 20 : Low [Default]
High**

**Pin 21 : Low [Default]
High**

**Pin 22 : Low [Default]
High**

**Pin 23 : Low [Default]
High**

**Pin 24 : Low [Default]
High**

EDID Setup : Reset

CONNECTORS, PINOUTS & JUMPERS

The various connectors are:

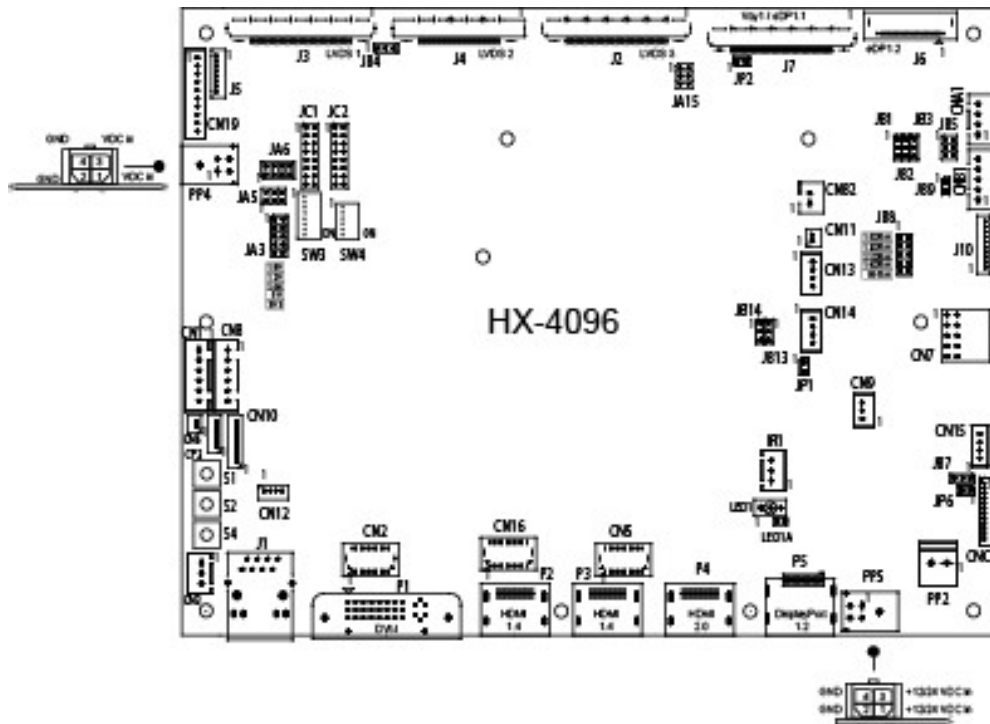

Summary: Connectors

Ref	Purpose	Description
CN1	Reserved for second RS-232 serial control	JST 6-way, B6B-XH-A (Matching type : XHP-6)
CN2	On board internal connector for DVI	JST BM29B-SRDS (Mating type : SHDR-20V-S-B) (Matching extend cable P/N: 426302900-3)
CN3	Reserved for external temperature sensor	JST 3-way, B3B-XH-A (Matching type : XHP-3)
CN5	On board internal connector for HDMI	JST BM20B-SRDS (Matching type : SHDR-20V-S-B)
CN6	Reserved for light sensor	DF13 2 ways (Matching type : DF13-2S-1.25C)
CN7	Audio board connector	Dual pin header 5x2, 0.1" pitch right angle (Matching audio add-on board P/N 416940020-3)
CN8	RS-232 serial control	JST 6-way, B6B-XH-A (Matching type : XHP-6)
CN9	Ambient light sensor connector	JST 3-way, B3B-PH-K (Matching type : PHR-3)
CN10	Reserved for Fan & backlight power monitoring connector	Hirose DF13-9P-1.25 DSA (Mating type : DF13-9S-1.25C)
CN11	SPDIF Audio output	JST B2B-ZR (Matching type : ZHR-2) (Matching extend cable P/N 426007400-3)
CN12	Reserved for engineering use	Reserved
CN13	Audio line in	JST B4B-ZR (Matching type : ZHR-4)
CN14	Audio line out	JST B4B-ZR (Matching type : ZHR-4) (Use audio cable P/N 426451800-3 to connect with audio add-on board P/N 416940020-3)
CN15	Power connector for IE-2000	Yeonho SMH200-04 (Matching type : SMH200-04) (Matching extend cable P/N:426307100-3)
CN16	On board internal connector for HDMI	JST BM20B-SRDS (Matching type : SHDR-20V-S-B)
CN19	Additional panel power output	JST B10B-PH-K (Matching type : PHR-10)
CNA1	Auxiliary power output	JST 4-way, B4B-XH-A (Matching type : XHP-4) (Matching cable P/N 426040200-3)
CNB1	Backlight inverter	JST 5-way, B5B-XH-A (Matching type : XHP-5) (Matching cable P/N 426058300-3)
CNB2	Backlight status input connector	JST 2 way, B2B-XH-A (Matching type : XHP-2)
CNC1	OSD control	Hirose DF13A-12P-1.25H (Mating type : DF13-12S-1.25C) (Matching OSD switch mount cable P/N 426122200-3 (150mm) or 426122210-3 (250mm))
CP2	Reserved	Reserved

Specifications subject to change without notice

IR1	Infra-red sensor connector	JST 3-way, B3B-XH-A	(Matching type : XHP-3)
J1	Ethernet	RJ-45 connector	
J2	LVDS 3	JAE FI-RE51S-HF	(Matching type : FI-RE51HL)
J3	LVDS 1	JAE FI-RE51S-HF	(Matching type : FI-RE51HL)
J4	LVDS 2	JAE FI-RE41S-HF	(Matching type : FI-RE41HL)
J5	Panel power output	JS-1147A-08 Top 1.25mm	(Matching type : JS-1146-08)
J6	eDP (1.2) connector	I-PEX 20455-030E-12	(Matching type : I-PEX 20454-030T)
J7	V-by-One panel signal output	JAE FI-RE51S-HF	(Matching type : FI-RE51HL)
J10	On board LED backlight driver connector	Molex 53261-1000	(Matching type : Molex 51021-1000)
LED1	Power LED connector	3-pins header	
P1	DVI-I -- D4 / VGA -- A0	DVI-I connector	
P2	HDMI (1.4) -- D3	HDMI connector	
P3	HDMI (1.4) -- D2	HDMI connector	
P4	HDMI (2.0) -- D1	HDMI connector	
P5	Display Port (1.2) -- D0	Display Port connector	
PP2	Power input (alternative)	DC power Molex 2 pin 0.156" pitch	
PP4	External panel power input	Molex 43045-0400 compatible (Matching connector type : Molex 43025-0400 compatible) (Matching power cable : P/N 426013710-3)	
PP5	12V/24VDC input power	Molex 43045-0400 compatible (Matching connector type : Molex 43025-0400 compatible) (Matching power cable : P/N 426013710-3)	
S1	Reset button (for Ethernet function)	Tact switch button	
S2	Reserved	Tact switch button	
S4	Config Menu button (for Ethernet function)	Tact switch button	
SW3	Panel selection	8-way DIP Switch	
SW4	Function selection	6-way DIP Switch	

Summary: Jumpers setting







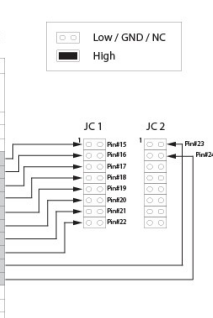
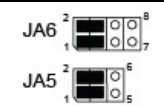
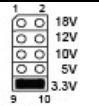

Ref	Purpose	Note																																																
JA3	Panel power voltage select CAUTION: Incorrect setting can damage panel	See panel voltage setting table 1																																																
JA5	Panel power voltage select CAUTION: Incorrect setting will cause panel damage	See panel voltage setting table 1																																																
JA6	Panel power voltage select CAUTION: Incorrect setting will cause panel damage	See panel voltage setting table 1																																																
JA15	Panel power output control via J7 (pin 1-8) and J6 (pin 5-9)	1-3, 2-4 = Enable panel power (3.3/5V) output on J7 and J6 3-5, 4-6 = Enable panel power (10/12/18/24V) output on J7 and J6 Open = Disable panel power output on J7 and J6																																																
JB1	Backlight brightness voltage range	1-2 = 5V max 2-3 = 3.3V max																																																
JB2	Backlight inverter on/off control – signal level	2-3 = On/Off control signal 'High' = +5V 1-2 = On/Off control signal 'High' = +3.3V Open = On/Off control signal 'High' = Open collector CAUTION: Incorrect setting can damage inverter.																																																
JB3	Backlight inverter on/off control – polarity	1-2 = control signal 'high' = Backlight ON 2-3 = control signal 'low' = Backlight ON																																																
JB4	Reserved for LVDS (J3) GPIO pins voltage selection	1-2 = 3.3V 2-3 = 5V																																																
JB5	Backlight control type selection	1-2 = VR/Digital switch mount control 3-4 = Analog backlight brightness - voltage range 0~5V 5-6 = PWM (Pulse Width Modulation) brightness																																																
JB7	Backlight control voltage on CNB1 pin 4 (Function when JB5 sets 1-2 closed)	Open = For OSD switch mount control (Default) 1-2 = 0V 2-3 = 3.3V / 5V controlled by JB1																																																
JB8	LED backlight current selection	150mA 120mA 110mA 100mA 90mA																																																
JB9	On board LED backlight driver function	Open = Disable Closed = Enable																																																
JB13	V-by-One / eDP selection on J7	1-2 = V-by-One 2-3 = eDP (1.1)																																																
JB14	V-by-One / eDP selection on J7	1-2 = V-by-One 2-3 = eDP (1.1)																																																
JC1 and JC2	Panel Specification (V-by-One's pin assignment) <table border="1" style="font-size: small;"> <thead> <tr> <th>Pin</th> <th>Name</th> <th>Description</th> </tr> </thead> <tbody> <tr><td>12</td><td>GND</td><td>Ground</td></tr> <tr><td>13</td><td>GND</td><td>Ground</td></tr> <tr><td>14</td><td>GND</td><td>Ground</td></tr> <tr><td>15</td><td>NC</td><td>NO CONNECTION</td></tr> <tr><td>16</td><td>NC</td><td>NO CONNECTION</td></tr> <tr><td>17</td><td>NC</td><td>NO CONNECTION</td></tr> <tr><td>18</td><td>NC</td><td>NO CONNECTION</td></tr> <tr><td>19</td><td>NC</td><td>NO CONNECTION</td></tr> <tr><td>20</td><td>NC</td><td>NO CONNECTION</td></tr> <tr><td>21</td><td>NC</td><td>NO CONNECTION</td></tr> <tr><td>22</td><td>NC</td><td>NO CONNECTION</td></tr> <tr><td>23</td><td>NC</td><td>NO CONNECTION</td></tr> <tr><td>24</td><td>GND</td><td>Ground</td></tr> <tr><td>25</td><td>HTPDN</td><td>Hot plug detect</td></tr> <tr><td>26</td><td>LOCKN</td><td>Lock detect</td></tr> </tbody> </table> 	Pin	Name	Description	12	GND	Ground	13	GND	Ground	14	GND	Ground	15	NC	NO CONNECTION	16	NC	NO CONNECTION	17	NC	NO CONNECTION	18	NC	NO CONNECTION	19	NC	NO CONNECTION	20	NC	NO CONNECTION	21	NC	NO CONNECTION	22	NC	NO CONNECTION	23	NC	NO CONNECTION	24	GND	Ground	25	HTPDN	Hot plug detect	26	LOCKN	Lock detect	Open = Low / GND / NC* Close = High * The setting of NC (No connection) is subject to the NC's state defined in panel specification.
Pin	Name	Description																																																
12	GND	Ground																																																
13	GND	Ground																																																
14	GND	Ground																																																
15	NC	NO CONNECTION																																																
16	NC	NO CONNECTION																																																
17	NC	NO CONNECTION																																																
18	NC	NO CONNECTION																																																
19	NC	NO CONNECTION																																																
20	NC	NO CONNECTION																																																
21	NC	NO CONNECTION																																																
22	NC	NO CONNECTION																																																
23	NC	NO CONNECTION																																																
24	GND	Ground																																																
25	HTPDN	Hot plug detect																																																
26	LOCKN	Lock detect																																																
JP1	Factory use	Default Open																																																
JP2	V-by-One power output configuration	1-2 = All pin 44 ~ pin 51 on J7 have power output Open = Only the upper four pins have power output (Refer to power output enabled/disabled on JA15. But not applicable if JA15 is set to OPEN)																																																
JP6	Input power control	Short = External switch control and fix the board ON Open = Switch mount control																																																

Table 1 : Panel voltage setting table :

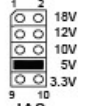

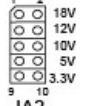

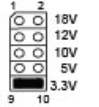

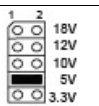
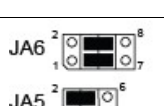
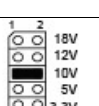
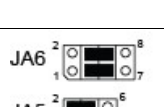
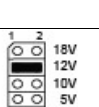
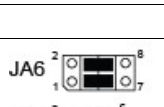
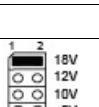

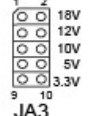

Input voltage via PP2/PP5	Panel Voltage	JA3	JA5	JA6	Jumper on board
12VDC	3.3V	3V3 closed	1-3 & 2-4	1-3 & 2-4	 
	5V	5V closed	1-3 & 2-4	1-3 & 2-4	 
	12V	OPEN	1-3 & 2-4	5-7 & 6-8	 

CAUTION: Incorrect setting can damage panel & controller

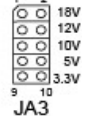
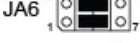
Input voltage via PP2/PP5	Panel Voltage	JA3	JA5	JA6	Jumper on board
24VDC**	3.3V	3V3 closed	1-3 & 2-4	1-3 & 2-4	 
	5V	5V closed	1-3 & 2-4	1-3 & 2-4	 
	10V	10V closed	1-3 & 2-4	3-5 & 4-6	 
	12V	12V closed	1-3 & 2-4	3-5 & 4-6	 
	18V	18V closed	1-3 & 2-4	3-5 & 4-6	 

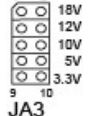
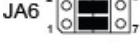
CAUTION: Incorrect setting can damage panel & controller

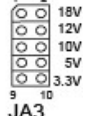
**** Ensure that the backlight inverter supports 24V operation prior to connecting a 24VDC input. Because CNA1 pin 1 and CNB1 pin 2 will output 24VDC if input 24VDC via PP5 or PP2.**

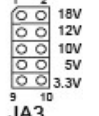
Input voltage via PP4	Input voltage via PP2 / PP5	Panel Voltage	JA3	JA5	JA6	Jumper on board
3.3 / 5 / 10 / 12 / 18VDC*	12V / 24VDC	3.3V	OPEN	3-5 & 4-6	1-3 & 2-4	  
		5V	OPEN	3-5 & 4-6	1-3 & 2-4	  
		10V	OPEN	3-5 & 4-6	3-5 & 4-6	  
		12V	OPEN	3-5 & 4-6	3-5 & 4-6	  
		18V	OPEN	3-5 & 4-6	3-5 & 4-6	  

* Maximum current for 3.3V, 5V = 7A, Maximum current for 10V, 12V = 5A, Maximum current for 18V = 3.5A

JA3, JA5 & JA6 location on board : (Please pay attention to the jumper settings on JA3, JA5 & JA6 which are red in color)

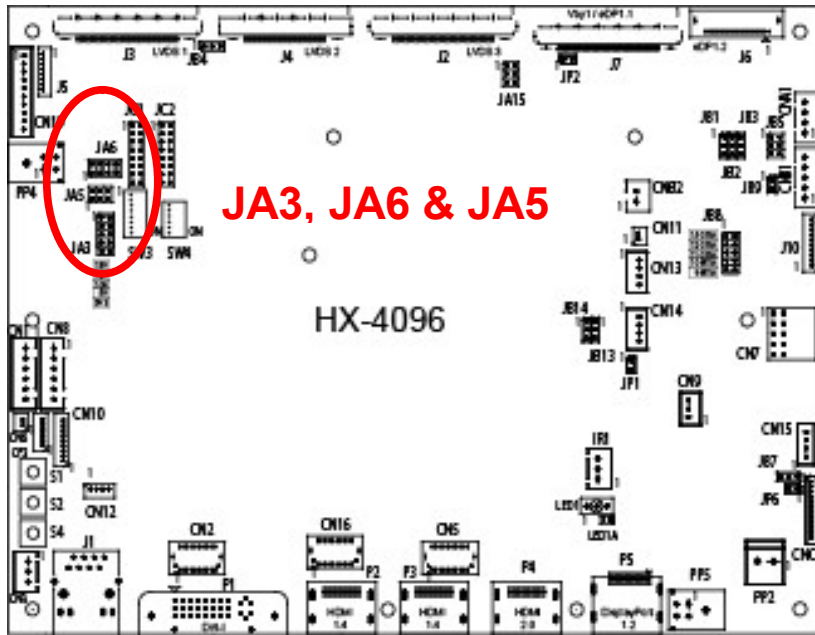

Table 2 : DIP Switch selection – SW3

Pos #1	Pos #2	Pos #3	Pos.#4	Description	Panel resolution
For 4K UHD panels					
OFF	OFF	OFF	OFF	IE-2000 (120Hz FRC)	3840 x 2160
OFF	OFF	OFF	OFF	V-By-One panel	3840 x 2160
ON	OFF	OFF	OFF	Reserved	3840 x 2160
OFF	ON	OFF	OFF	Reserved	3840 x 2160
ON	ON	OFF	OFF	Reserved	3840 x 2160
OFF	OFF	ON	OFF	eDP1.2 panel	3840 x 2160
OFF	OFF	OFF	ON	Reserved	3840 x 2160
For WUXGA panels					
OFF	OFF	OFF	OFF	LVDS panel	1920 x 1200
ON	OFF	OFF	OFF	LVDS panel	1920 x 1080

Remark : The above panel timings are generated based on the panel specification. Some of the panel timings settings may not exactly to match the panel model we specified in this table.

Pos #5	Pos #6	Pos #7	Description
OFF	OFF	OFF	WUXGA (1920 x 1200 / 1080)
ON	OFF	OFF	Reserved
OFF	ON	OFF	Reserved
ON	ON	OFF	Reserved
OFF	OFF	ON	Reserved
ON	OFF	ON	Reserved
OFF	ON	ON	4K UHD (3840 x 2160)
ON	ON	ON	Others
Pos. #8			Reserved

Table 3 : DIP switch selection – SW4

Pos #	Function	Description															
1	LVDS data mapping	OFF: VESA ON: JEIDA															
2 and 3	Panel display division	<table border="0"> <tr> <td><i>Pos#3</i></td> <td><i>Pos#2</i></td> <td></td> </tr> <tr> <td>OFF</td> <td>OFF</td> <td>1 division (Non-division)</td> </tr> <tr> <td>OFF</td> <td>ON</td> <td>2 division</td> </tr> <tr> <td>ON</td> <td>OFF</td> <td>4 division</td> </tr> <tr> <td>ON</td> <td>ON</td> <td>8 division</td> </tr> </table>	<i>Pos#3</i>	<i>Pos#2</i>		OFF	OFF	1 division (Non-division)	OFF	ON	2 division	ON	OFF	4 division	ON	ON	8 division
<i>Pos#3</i>	<i>Pos#2</i>																
OFF	OFF	1 division (Non-division)															
OFF	ON	2 division															
ON	OFF	4 division															
ON	ON	8 division															
4	Output display bit mode	OFF: 10-bit ON: 8-bit															
5	Reserved	Reserved															
6	V-by-One settings	OFF: Determine by JC1 and JC2 ON: Determine by OSD menu <small>Note: For setting definition, please refer to V-by-One's pin#15 to pin#24 of panel specification.</small>															

Panel support

4K 60Hz panel		
<i>Manufacturer</i>	<i>Panel model</i>	<i>Panel resolution</i>
AU Optronics	M270DAN02.3	2560 x 1440
AU Optronics	M320QAN01.0	3840 x 2160
AU Optronics	P550QVN01.0	3840 x 2160
AU Optronics	P750QVN01.1	3840 x 2160
BOE	MV238QUM-N20	3840 x 2160
Innolux	M238DCJ-E50	3840 x 2160
Innolux	M280DGJ-L30*	3840 x 2160
Innolux	M315DJJ-K30	3840 x 2160
Innolux	N173DSE-G31	3840 x 2160
Innolux	S400DJ1-KS5	3840 x 2160
Innolux	V400DK2-KS5	3840 x 2160
Innolux	V420DK1-KS1	3840 x 2160
Innolux	V500DK1-LS1	3840 x 2160
Innolux	V500DK2-KS1	3840 x 2160
LG	LC430EQE-FHM1	3840 x 2160
LG	LC490EQE-FHM2	3840 x 2160
LG	LC550EQE-FHM1	3840 x 2160
LG	LD550EGE-FHM1	3840 x 2160
LG	LD750DGN-FKH1	3840 x 2160
LG	LM238WR1-SLA1	3840 x 2160
LG	LM238WR2-SLC1	3840 x 2160
LG	LM270WR2-SPA1	3840 x 2160
LG	LM300WQ6-SLA1	2560 x 1600
LG	LM315WR1-SSA1	3840 x 2160
Samsung	LTM236FL01	3840 x 2160
Samsung	LTM270FL01*	3840 x 2160

4K 120Hz panel		
<i>Manufacturer</i>	<i>Panel model</i>	<i>Panel resolution</i>
AU Optronics	P650QVN01.0*	3840 x 2160
AU Optronics	P750QVN01.0	3840 x 2160
Innolux	V400DK2-KS5	3840 x 2160
Innolux	V500DK1-KS2	3840 x 2160
Innolux	V500DK1-KS5	3840 x 2160
Innolux	V850DK1-KD1	3840 x 2160
LG	LC550EQD-FGF2	3840 x 2160
LG	LD750EQF-FJM1	3840 x 2160
LG	LD840EQD-SEM1	3840 x 2160
LG	LD860EQD-FJM1	3840 x 2160
LG	LD980DQD-FGM1	3840 x 2160
LG	ND840EQD-SADX1	3840 x 2160

Remark :

1. The panel model marked with (*) means the model has been verified by DigitalView.
2. The panel model without marked with (*) means the model has not been tested and verified but have a suggested connection diagram provide.
3. For the 4K 120Hz panel connection, IE-2000 is required.

CN1 – RS-232 serial control (2nd): JST B6B-XH-A (Matching type : XHP-6)

PIN	SYMBOL	DESCRIPTION
1	NC	No connection
2	NC	No connection
3	VCC	+5V
4	TXD	RS-232 Tx data
5	GND	Ground
6	RXD	RS-232 Rx data

CN2 – Alternate DVI connector: JST BM20B-SRDS (Matching type : SHDR-20V-S-B)

PIN	SYMBOL	DESCRIPTION
1	GND	Digital Ground
2	GND	Digital Ground
3	RXC	TMDS Clock+
4	/RXC	TMDS Clock-
5	RX0	TMDS Data 0+
6	/RX0	TMDS Data 0-
7	RX1	TMDS Data 1+
8	/RX1	TMDS Data 1-
9	RX2	TMDS Data 2+
10	/RX2	TMDS Data 2-
11	GND	Ground (+5, Analog H/V Sync)
12	GND	Digital Ground
13	EXT_SCL	Reserved
14	EXT_SDA	Reserved
15	DDC_5V	+5V power supply for DDC (optional)
16	HPD	Hot plug detect
17	DDC_CLK	DDC Clock
18	DDC_DAT	DDC Data
19	NC	No connection
20	VCC	+5V

CN3 – Temperature sensor connector : JST B3B-XH-A (Matching type : XHP-3)

PIN	SYMBOL	DESCRIPTION
1	GND	Ground
2	VDD	+3.3V
3	EX_TMP_SENSOR	Temperature sensor input

CN5 - Alternate HDMI connector : JST BM20B-SRDS (Matching type : SHDR-20V-S-B)

PIN	SYMBOL	DESCRIPTION
1	GND	Ground
2	GND	Ground
3	RXC+	TMDS Data C+
4	RXC-	TMDS Data C-
5	RX0+	TMDS Data 0+
6	RX0-	TMDS Data 0-
7	RX1+	TMDS Data 1+
8	RX1-	TMDS Data 1-
9	RX2+	TMDS Data 2+
10	RX2-	TMDS Data 2-
11	GND	Ground
12	GND	Ground
13	EXT_SCL	Reserved
14	EXT_SDA	Reserved
15	DDC_5V	+5V power supply for DDC (optional)
16	HPD	Hot plug detection
17	DDC_SCL	DDC serial clock
18	DDC_SDA	DDC Data
19	NC	No connection
20	VCC	+5V

CN6 – Light sensor connector : DF13 2-ways (Matching type : DF13-2S-1.25C)

PIN	SYMBOL	DESCRIPTION
1	SENSOR	Light sensor input
2	VDD	+3.3V

CN7 - Audio line out : 2x5 right angled header (Matching audio add-on board P/N 416940020-3 & Audio extend cable P/N 426009700-3)

PIN	SYMBOL	DESCRIPTION
1	VCC	Audio board logic power supply, +5V
2	VOLSEL0	Reserved
3	VOLSEL1	Reversed
4	TUNAUSEL	Reserved
5	CLK/CNT	Reserved
6	GND	Ground
7	+12V/+24V	Audio board power supply, +12V/+24V
8	NC	No connection
9	NC	No connection
10	GND	Ground

CN8 – RS-232 serial control: JST B6B-XH-A (Matching type : XHP-6)

PIN	SYMBOL	DESCRIPTION
1	EXT_SCL	Reserved
2	EXT_SDA	Reserved
3	VCC	+5V
4	TXD	RS-232 Tx data
5	GND	Ground
6	RXD	RS-232 Rx data

CN9 – Ambient light sensor connector : JST B3B-PH-K (Matching type : PHR-3)

PIN	SYMBOL	DESCRIPTION
1	GND	Ground
2	VCC 5V	VCC 5V
3	ALSF	Ambient light sensing feedback

CN10 - Fan and backlight power monitoring connector : Hirose DF13-9P-1.25 DSA (Matching type : DF13-9S-1.25C)

PIN	SYMBOL	DESCRIPTION
1	GND	Ground
2	TACH1_IN	Tachometer IN of Fan 1
3	GND	Ground
4	TACH2_IN	Tachometer IN of Fan 2
5	GND	Ground
6	PS_V1_IN	Power sense input 1
7	GND	Ground
8	PS_V2_IN	Power sense input 2
9	AUX	Reserved

CN11 – SPDIF audio output connector : JST B2B-ZR (Matching type : ZHR-2)

PIN	SYMBOL	DESCRIPTION
1	SPDIF	SPDIF Digital audio output
2	GND	Ground

CN12 – Reserved

CN13 - Audio line in: JST B4B-ZR (Matching type : ZHR-4)

PIN	SYMBOL	DESCRIPTION
1	GND	Ground
2	LINE_IN_L	Line in (Left)
3	GND	Ground
4	LINE_IN_R	Line in (Right)

CN14 - Audio line out: JST B4B-ZR (Matching type : ZHR-4)

PIN	SYMBOL	DESCRIPTION
1	GND	Ground
2	AUDIO_OUT_L	Audio out (Left)
3	GND	Ground
4	AUDIO_OUT_R	Audio out (Right)

CN15 – Power connector for IE-2000: Yeonho SMH200-04 (Matching type: SMH200-04)

PIN	SYMBOL	DESCRIPTION
1	12/24VA	+12/24 VDC
2	12/24VA	+12/24 VDC
3	GND	Ground
4	GND	Ground

CN16 - Alternate HDMI connector : JST BM20B-SRDS (Matching type : SHDR-20V-S-B)

PIN	SYMBOL	DESCRIPTION
1	GND	Ground
2	GND	Ground
3	RXC+	TMD5 Data C+
4	RXC-	TMD5 Data C-
5	RX0+	TMD5 Data 0+
6	RX0-	TMD5 Data 0-
7	RX1+	TMD5 Data 1+
8	RX1-	TMD5 Data 1-
9	RX2+	TMD5 Data 2+
10	RX2-	TMD5 Data 2-
11	GND	Ground
12	GND	Ground
13	EXT_SCL	Reserved
14	EXT_SDA	Reserved
15	DDC_5V	+5V power supply for DDC (optional)
16	NC	No connection
17	DDC_SCL	DDC serial clock
18	DDC_SDA	DDC Data
19	CEC	Consumer Electronics Control(CEC) pin
20	VCC	+5V

CN19 – Additional panel power output : JST B10B-PH-K (Matching type : PHR-10)

PIN	SYMBOL	DESCRIPTION
1	PVLCD_High	Panel power supply (+10V / 12V / 18V) (selected by JA3, JA5 & JA6)
2	PVLCD_High	Panel power supply (+10V / 12V / 18V) (selected by JA3, JA5 & JA6)
3	PVLCD_High	Panel power supply (+10V / 12V / 18V) (selected by JA3, JA5 & JA6)
4	PVLCD_High	Panel power supply (+10V / 12V / 18V) (selected by JA3, JA5 & JA6)
5	PVLCD_High	Panel power supply (+10V / 12V / 18V) (selected by JA3, JA5 & JA6)
6	GND	Ground
7	GND	Ground
8	GND	Ground
9	GND	Ground
10	GND	Ground

CNA1 - Auxiliary power output: JST B4B-XH-A (Matching type : XHP-4)

PIN	SYMBOL	DESCRIPTION
1	AUX 12V / 24V	+12V / +24V DC
2	GND	Ground
3	GND	Ground
4	AUX 5V	+5V DC, 500mA max

CNB1 – Backlight inverter connector: JST B5B-XH-A (Matching type : XHP-5)

PIN	SYMBOL	DESCRIPTION
1	GND	Ground
2	VBKL	+12V / +24V DC, backlight power supply
3	BLCTRL	On/Off control (enable) – see JB2 & JB3
4	BVR_WIP	Brightness VR – WIP
5	BVR_A	Brightness VR A

CNB2 – Backlight status input inverter connector: JST B2B-XH-A (Matching type : XHP-2)

PIN	SYMBOL	DESCRIPTION
1	BL_STATUS	Backlight status (Normal = High)
2	GND	Ground

CNC1 – OSD switch mount control, Hirose DF13A-12P-1.25H (Mating type : DF13-12S-1.25C)

PIN	SYMBOL	DESCRIPTION
1	PSWIN	Power button A
2	SW_ON	Power button B
3	BVR_A	Backlight Brightness VR pin A
4	BVR_WIP	Backlight Brightness R pin WIP
5	BVR_B	Backlight Brightness VR pin B (470 ohm resistor to +5V Vcc)
6	GND	Ground
7	MENU	OSD menu
8	-/LEFT	OSD -/Left
9	+/RIGHT	OSD +/Right
10	SEL_DN	OSD Select down
11	SEL_UP	OSD Select up
12	NC	No connection

The VR for brightness depends on the inverter. The main power load for On/Off is handled by a relay on the controller.

CP2 - Reserved

IR1 – Infra-Red sensor connector: JST B3B-XH-A (Matching type : XHP-3)

PIN	SYMBOL	DESCRIPTION
1	GND	Ground
2	VCC	+3.3V
3	IR Data	IR data

J1 – Ethernet connector: RJ-45 connector

PIN	SYMBOL	DESCRIPTION
1	TX+	Transmit data +
2	TX-	Transmit data -
3	RX+	Receive data +
4	CMT1	Network use
5	CMT1	Network use
6	RX-	Receive data -
7	CMT3	Network use
8	CMT3	Network use

J2 – LVDS_3 output connector: JAE FI-RE51S-HF (Matching type : JAE FI-RE51HL)

PIN	SYMBOL	DESCRIPTION
1	GND	Ground
2	LVDS_OUT3_D4+	Positive differential LVDS data bit D4
3	LVDS_OUT3_D4-	Negative differential LVDS data bit D4
4	LVDS_OUT3_D3+	Positive differential LVDS data bit D3
5	LVDS_OUT3_D3-	Negative differential LVDS data bit D3
6	LVDS_OUT3_DC+	Positive LVDS clock for D channel
7	LVDS_OUT3_DC-	Negative LVDS clock for D channel
8	LVDS_OUT3_D2+	Positive differential LVDS data bit D2
9	LVDS_OUT3_D2-	Negative differential LVDS data bit D2
10	LVDS_OUT3_D1+	Positive differential LVDS data bit D1
11	LVDS_OUT3_D1-	Negative differential LVDS data bit D1
12	LVDS_OUT3_D0+	Positive differential LVDS data bit D0
13	LVDS_OUT3_D0-	Negative differential LVDS data bit D0
14	LVDS_OUT3_C4+	Positive differential LVDS data bit C4
15	LVDS_OUT3_C4-	Negative differential LVDS data bit C4
16	LVDS_OUT3_C3+	Positive differential LVDS data bit C3
17	LVDS_OUT3_C3-	Negative differential LVDS data bit C3
18	LVDS_OUT3_CC+	Positive LVDS clock for C channel
19	LVDS_OUT3_CC-	Negative LVDS clock for C channel
20	LVDS_OUT3_C2+	Positive differential LVDS data bit C2
21	LVDS_OUT3_C2-	Negative differential LVDS data bit C2
22	LVDS_OUT3_C1+	Positive differential LVDS data bit C1
23	LVDS_OUT3_C1-	Negative differential LVDS data bit C1
24	LVDS_OUT3_C0+	Positive differential LVDS data bit C0
25	LVDS_OUT3_C0-	Negative differential LVDS data bit C0
26	GND	Ground
27	LVDS_OUT3_B4+	Positive differential LVDS data bit B4
28	LVDS_OUT3_B4-	Negative differential LVDS data bit B4
29	LVDS_OUT3_B3+	Positive differential LVDS data bit B3
30	LVDS_OUT3_B3-	Negative differential LVDS data bit B3
31	LVDS_OUT3_BC+	Positive LVDS clock for B channel
32	LVDS_OUT3_BC-	Negative LVDS clock for B channel
33	LVDS_OUT3_B2+	Positive differential LVDS data bit B2
34	LVDS_OUT3_B2-	Negative differential LVDS data bit B2
35	LVDS_OUT3_B1+	Positive differential LVDS data bit B1
36	LVDS_OUT3_B1-	Negative differential LVDS data bit B1
37	LVDS_OUT3_B0+	Positive differential LVDS data bit B0
38	LVDS_OUT3_B0-	Negative differential LVDS data bit B0
39	LVDS_OUT3_A4+	Positive differential LVDS data bit A4
40	LVDS_OUT3_A4-	Negative differential LVDS data bit A4
41	LVDS_OUT3_A3+	Positive differential LVDS data bit A3
42	LVDS_OUT3_A3-	Negative differential LVDS data bit A3
43	LVDS_OUT3_AC+	Positive LVDS clock for A channel
44	LVDS_OUT3_AC-	Negative LVDS clock for A channel
45	LVDS_OUT3_A2+	Positive differential LVDS data bit A2
46	LVDS_OUT3_A2-	Negative differential LVDS data bit A2
47	LVDS_OUT3_A1+	Positive differential LVDS data bit A1
48	LVDS_OUT3_A1-	Negative differential LVDS data bit A1
49	LVDS_OUT3_A0+	Positive differential LVDS data bit A0
50	LVDS_OUT3_A0-	Negative differential LVDS data bit A0

Specifications subject to change without notice

51	GND	Ground
----	-----	--------

J3 – LVDS_1 output connector: JAE FI-RE51S-HF (Matching type : JAE FI-RE51HL)

PIN	SYMBOL	DESCRIPTION
1	VLCD HV	Panel power supply (+10V / 12V / 18V)
2	VLCD HV	Panel power supply (+10V / 12V / 18V)
3	VLCD HV	Panel power supply (+10V / 12V / 18V)
4	VLCD HV	Panel power supply (+10V / 12V / 18V)
5	VLCD HV	Panel power supply (+10V / 12V / 18V)
6	VLCD LV	Panel power supply (3,3V/5V)
7	VLCD LV	Panel power supply (3,3V/5V)
8	VLCD LV	Panel power supply (3,3V/5V)
9	VLCD LV	Panel power supply (3,3V/5V)
10	VLCD LV	Panel power supply (3,3V/5V)
11	GND	Ground
12	GND	Ground
13	GND	Ground
14	GND	Ground
15	GND	Ground
16	OP1	-
17	OP2	-
18	OP3	-
19	OP4	-
20	GND	Ground
21	GND	Ground
22	LVDS_OUT1_A4+	Positive differential LVDS data bit A4
23	LVDS_OUT1_A4-	Negative differential LVDS data bit A4
24	LVDS_OUT1_A3+	Positive differential LVDS data bit A3
25	LVDS_OUT1_A3-	Negative differential LVDS data bit A3
26	GND	Ground
27	LVDS_OUT1_AC+	Positive LVDS clock for A channel
28	LVDS_OUT1_AC-	Negative LVDS clock for A channel
29	GND	Ground
30	LVDS_OUT1_A2+	Positive differential LVDS data bit A2
31	LVDS_OUT1_A2-	Negative differential LVDS data bit A2
32	LVDS_OUT1_A1+	Positive differential LVDS data bit A1
33	LVDS_OUT1_A1-	Negative differential LVDS data bit A1
34	LVDS_OUT1_A0+	Positive differential LVDS data bit A0
35	LVDS_OUT1_A0-	Negative differential LVDS data bit A0
36	GND	Ground
37	LVDS_OUT1_B4+	Positive differential LVDS data bit B4
38	LVDS_OUT1_B4-	Negative differential LVDS data bit B4
39	LVDS_OUT1_B3+	Positive differential LVDS data bit B3
40	LVDS_OUT1_B3-	Negative differential LVDS data bit B3
41	GND	Ground
42	LVDS_OUT1_BC+	Positive LVDS clock for B channel
43	LVDS_OUT1_BC-	Negative LVDS clock for B channel
44	GND	Ground
45	LVDS_OUT1_B2+	Positive differential LVDS data bit B2
46	LVDS_OUT1_B2-	Negative differential LVDS data bit B2
47	LVDS_OUT1_B1+	Positive differential LVDS data bit B1
48	LVDS_OUT1_B1-	Negative differential LVDS data bit B1
49	LVDS_OUT1_B0+	Positive differential LVDS data bit B0
50	LVDS_OUT1_B0-	Negative differential LVDS data bit B0
51	GND	Ground

J4 – LVDS_2 output connector: JAE FI-RE41S-HF (Matching type : JAE FI-RE41HL)

PIN	SYMBOL	DESCRIPTION
1	GND	Ground
2	LVDS_OUT2_B0-	Negative differential LVDS data bit B0
3	LVDS_OUT2_B0+	Positive differential LVDS data bit B0
4	LVDS_OUT2_B1-	Negative differential LVDS data bit B1
5	LVDS_OUT2_B1+	Positive differential LVDS data bit B1
6	LVDS_OUT2_B2-	Negative differential LVDS data bit B2
7	LVDS_OUT2_B2+	Positive differential LVDS data bit B2
8	LVDS_OUT2_BC-	Negative LVDS clock for B channel
9	LVDS_OUT2_BC+	Positive LVDS clock for B channel
10	GND	Ground
11	LVDS_OUT2_B3-	Negative differential LVDS data bit B3
12	LVDS_OUT2_B3+	Positive differential LVDS data bit B3
13	GND	Ground
14	LVDS_OUT2_B4-	Negative differential LVDS data bit B4
15	LVDS_OUT2_B4+	Positive differential LVDS data bit B4
16	GND	Ground
17	LVDS_OUT2_A0-	Negative differential LVDS data bit A0
18	LVDS_OUT2_A0+	Positive differential LVDS data bit A0
19	LVDS_OUT2_A1-	Negative differential LVDS data bit A1
20	LVDS_OUT2_A1+	Positive differential LVDS data bit A1
21	LVDS_OUT2_A2-	Negative differential LVDS data bit A2
22	LVDS_OUT2_A2+	Positive differential LVDS data bit A2
23	LVDS_OUT2_AC-	Negative LVDS clock for A channel
24	LVDS_OUT2_AC+	Positive LVDS clock for A channel
25	GND	Ground
26	LVDS_OUT2_A3-	Negative differential LVDS data bit A3
27	LVDS_OUT2_A3+	Positive differential LVDS data bit A3
28	GND	Ground
29	LVDS_OUT2_A4-	Negative differential LVDS data bit A4
30	LVDS_OUT2_A4+	Positive differential LVDS data bit A4
31	GND	Ground
32	GND	Ground
33	GND	Ground
34	GND	Ground
35	GND	Ground
36	GND	Ground
37	NC	No connection
38	NC	No connection
39	NC	No connection
40	NC	No connection
41	NC	No connection

J5 – Panel power output connector: JS-1147A-08 Top 1.25mm (Matching type : JS-1146-08)

PIN	SYMBOL	DESCRIPTION
1	PVLCD_Low (3,3V/5V)	Panel power supply (3,3V/5V)
2	PVLCD_Low (3,3V/5V)	Panel power supply (3,3V/5V)
3	GND	Ground
4	GND	Ground
5	GND	Ground
6	PVLCD_High	Panel power supply (+10V / 12V / 18V)
7	PVLCD_High	Panel power supply (+10V / 12V / 18V)
8	PVLCD_High	Panel power supply (+10V / 12V / 18V)

J6 – eDP (1.2) connector: I-PEX 20455-030E-12 (Matching type : I-PEX 20454-030T)

PIN	SYMBOL	DESCRIPTION
1	GND	Ground
2	GND	Ground
3	GND	Ground
4	GND	Ground
5	PANEL_VCC	Panel power selected by JA15
6	PANEL_VCC	Panel power selected by JA15
7	PANEL_VCC	Panel power selected by JA15
8	PANEL_VCC	Panel power selected by JA15
9	NC	NC
10	DP_TX_33V	Power for connector (3.3V 500mA)
11	GND	Ground
12	DPTX_HPDP	Hot Plug Detect
13	DPTX_AUX_N	Auxiliary Channel (negative)
14	GND	Ground

Specifications subject to change without notice

15	DPTX_AUX_P	Auxiliary Channel (positive)
16	GND	Connected to Ground
17	GND	Connected to Ground
18	DPTX_L3N	Lane 3 (negative)
19	GND	Ground
20	DPTX_L3P	Lane 3 (positive)
21	DPTX_L2N	Lane 2 (negative)
22	GND	Ground
23	DPTX_L2P	Lane 2 (positive)
24	DPTX_L1N	Lane 1 (negative)
25	GND	Ground
26	DPTX_L1P	Lane 1 (positive)
27	DPTX_L0N	Lane 0 (negative)
28	GND	Ground
29	DPTX_L0P	Lane 0 (positive)
30	GND	Ground

J7 – V-by-One panel signal output connector: JAE FI-RE51S-HF (Matching type : JAE FI-RE51HL)

PIN	SYMBOL	DESCRIPTION
1	(51) GND	Ground
2	(50) VB1_TX7P	V-by-One HS Data Lane 7
3	(49) VB1_TX7N	V-by-One HS Data Lane 7
4	(48) GND	Ground
5	(47) VB1_TX6P	V-by-One HS Data Lane 6
6	(46) VB1_TX6N	V-by-One HS Data Lane 6
7	(45) GND	Ground
8	(44) VB1_TX5P	V-by-One HS Data Lane 5
9	(43) VB1_TX5N	V-by-One HS Data Lane 5
10	(42) GND	Ground
11	(41) VB1_TX4P	V-by-One HS Data Lane 4
12	(40) VB1_TX4N	V-by-One HS Data Lane 4
13	(39) GND	Ground
14	(38) VB1_TX3P	V-by-One HS Data Lane 3
15	(37) VB1_TX3N	V-by-One HS Data Lane 3
16	(36) GND	Ground
17	(35) VB1_TX2P	V-by-One HS Data Lane 2
18	(34) VB1_TX2N	V-by-One HS Data Lane 2
19	(33) GND	Ground
20	(32) VB1_TX1P	V-by-One HS Data Lane 1
21	(31) VB1_TX1N	V-by-One HS Data Lane 1
22	(30) GND	Ground
23	(29) VB1_TX0P	V-by-One HS Data Lane 0
24	(28) VB1_TX0N	V-by-One HS Data Lane 0
25	(27) GND	Ground
26	(26) LOCKN	V-by-One LOCK
27	(25) HTPDN	V-by-One HTPDN
28	(24) OP10	High/Low state control
29	(23) OP9	High/Low state control
30	(22) OP8	High/Low state control
31	(21) OP7	High/Low state control
32	(20) OP6	High/Low state control
33	(19) OP5 / PANEL_SCL	High/Low state control / Panel I ² C SCL
34	(18) OP4 / PANEL_SDA	High/Low state control / Panel I ² C SDA
35	(17) OP3	High/Low state control
36	(16) OP2	High/Low state control
37	(15) OP1	High/Low state control
38	(14) GND	Ground
39	(13) GND	Ground
40	(12) GND	Ground
41	(11) GND	Ground
42	(10) GND	Ground
43	(9) NC	No Connection
44	(8) PVLCD_High	Panel power supply (selected by JA15 & JP2)
45	(7) PVLCD_High	Panel power supply (selected by JA15 & JP2)
46	(6) PVLCD_High	Panel power supply (selected by JA15 & JP2)
47	(5) PVLCD_High	Panel power supply (selected by JA15 & JP2)
48	(4) PVLCD_High	Panel power supply (selected by JA15 & JP2)
49	(3) PVLCD_High	Panel power supply (selected by JA15 & JP2)
50	(2) PVLCD_High	Panel power supply (selected by JA15 & JP2)
51	(1) PVLCD_High	Panel power supply (selected by JA15 & JP2)

(1) - (51): Pin# read on panel side.

J10 – On-board LED backlight driver connection : Molex 53261-1000 (Matching type : Molex 51021-1000)

PIN	SYMBOL	DESCRIPTION
1	LED_VLED1+	Channel A – Anode
2	LED_VLED1+	Channel A – Anode
3	LED_CH4	Channel A – Cathode 1
4	LED_CH3	Channel A – Cathode 2
5	LED_CH2	Channel A – Cathode 3
6	LED_CH1	Channel A – Cathode 4
7	NC	No Connection
8	NC	No Connection
9	NC	No Connection
10	NC	No Connection

LED1 – Status LED connector: 3-pin header

PIN	DESCRIPTION
1	Green LED pin (anode)
2	LED pin common (cathode)
3	Red LED pin (anode)

P1 – DVI-I (Dual link) in

PIN	SYMBOL	DESCRIPTION
1	/RX2	TMDS Data 2-
2	RX2	TMDS Data 2+
3	GND	Digital Ground
4	/Rx4	TMDS Data 4-
5	Rx4	TMDS Data 4+
6	DDC_CLK	DDC Clock
7	DDC_DAT	DDC Data
8	VS_IN	Analog Vertical Sync
9	/RX1	TMDS Data 1-
10	RX1	TMDS Data 1+
11	GND	Digital Ground
12	/Rx3	TMDS Data 3-
13	Rx3	TMDS Data 3+
14	DDC_5V	+5V power supply for DDC (optional)
15	GND	Ground
16	HPD	Hot Plug Detect
17	/RX0	TMDS Data 0-
18	RX0	TMDS Data 0+
19	GND	Digital Ground
20	/Rx5	TMDS Data 5-
21	Rx5	TMDS Data 5+
22	GND	Digital Ground
23	RXC	TMDS Clock+
24	/RXC	TMDS Clock-
C1	RIN	Analog Red
C2	GIN	Analog Green
C3	BIN	Analog Blue
C4	HS_IN	Analog horizontal sync
C5	GND	Ground
C6	NC	No connection

P2 – HDMI (1.4) connector

PIN	SYMBOL	DESCRIPTION
1	DATA2+	TMDS Data2+
2	DATA2S	TMDS Data2 Shield
3	DATA2-	TMDS Data2-
4	DATA1+	TMDS Data1+
5	DATA1S	TMDS Data1 Shield
6	DATA1-	TMDS Data1-
7	DATA0+	TMDS Data0+
8	DATA0S	TMDS Data0 Shield
9	DATA0-	TMDS Data0-
10	CLK+	TMDS Clock+
11	CLK@	TMDS Clock Shield
12	CLK-	TMDS Clock-
13	NC	No connection
14	NC	No connection
15	SCL	SCL (I ² C Serial Clock for DDC)
16	SDA	SDA (I ² C Serial Data Line for DDC)
17	GND	Ground

Specifications subject to change without notice

18	+5V	+5 V Power (max 50 mA)
19	HPDET	Hot Plug Detect

P3 – HDMI (1.4) connector

PIN	SYMBOL	DESCRIPTION
1	DATA2+	TMDS Data2+
2	DATA2S	TMDS Data2 Shield
3	DATA2-	TMDS Data2-
4	DATA1+	TMDS Data1+
5	DATA1S	TMDS Data1 Shield
6	DATA1-	TMDS Data1-
7	DATA0+	TMDS Data0+
8	DATA0S	TMDS Data0 Shield
9	DATA0-	TMDS Data0-
10	CLK+	TMDS Clock+
11	CLK@	TMDS Clock Shield
12	CLK-	TMDS Clock-
13	NC	No connection
14	NC	No connection
15	SCL	SCL (I ² C Serial Clock for DDC)
16	SDA	SDA (I ² C Serial Data Line for DDC)
17	GND	Ground
18	+5V	+5 V Power (max 50 mA)
19	HPDET	Hot Plug Detect

P4 – HDMI (2.0) connector

PIN	SYMBOL	DESCRIPTION
1	DATA2+	TMDS Data2+
2	DATA2S	TMDS Data2 Shield
3	DATA2-	TMDS Data2-
4	DATA1+	TMDS Data1+
5	DATA1S	TMDS Data1 Shield
6	DATA1-	TMDS Data1-
7	DATA0+	TMDS Data0+
8	DATA0S	TMDS Data0 Shield
9	DATA0-	TMDS Data0-
10	CLK+	TMDS Clock+
11	CLK@	TMDS Clock Shield
12	CLK-	TMDS Clock-
13	NC	No connection
14	NC	No connection
15	SCL	SCL (I ² C Serial Clock for DDC)
16	SDA	SDA (I ² C Serial Data Line for DDC)
17	GND	Ground
18	+5V	+5 V Power (max 50 mA)
19	HPDET	Hot Plug Detect

P5 – Display Port (1.2) connector

PIN	SYMBOL	DESCRIPTION
1	ML_Lane 3 (n)	Lane 3 (negative)
2	GND	Ground
3	ML_Lane 3 (p)	Lane 3 (positive)
4	ML_Lane 2 (n)	Lane 2 (negative)
5	GND	Ground
6	ML_Lane 2 (p)	Lane 2 (positive)
7	ML_Lane 1 (n)	Lane 1 (negative)
8	GND	Ground
9	ML_Lane 1 (p)	Lane 1 (positive)
10	ML_Lane 0 (n)	Lane 0 (negative)
11	GND	Ground
12	ML_Lane 0 (p)	Lane 0 (positive)
13	CONFIG1	connected to Ground
14	CONFIG2	connected to Ground
15	AUX CH (p)	Auxiliary Channel (positive)
16	GND	Ground
17	AUX CH (n)	Auxiliary Channel (negative)
18	Hot Plug	Hot Plug Detect
19	GND	Ground
20	DP_PWR	Power for connector (3.3 V 500 mA)

PP5 – 12V/24VDC input power: Molex 43045-0400 or compatible (Matching type : Molex 43025-0400 or compatible)

PIN	DESCRIPTION
1	+12VDC / 24VDC in
2	Ground
3	+12VDC / 24VDC in
4	Ground

PP2 – Alternate 12V/24VDC input power: Molex 2 pin 0.156" pitch

PIN	DESCRIPTION
1	+12VDC / 24VDC in
2	Ground

PP4 – External panel power input: Molex 43045-0400 or compatible (Matching type : Molex 43025-0400 or compatible)

PIN	DESCRIPTION
1	External panel power
2	Ground
3	External panel power
4	Ground

CONTROLLER DIMENSIONS

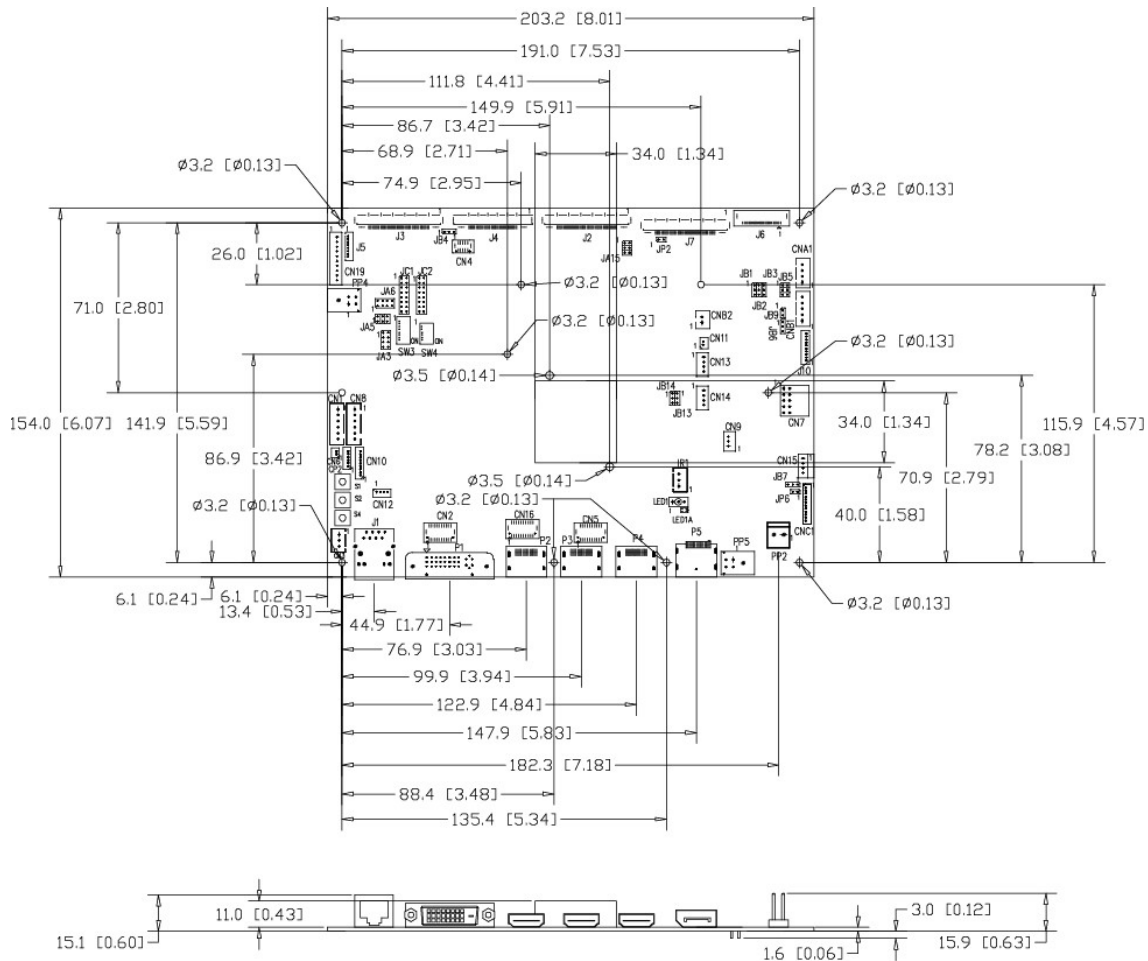

Ready-made 3D Pro-E (SLDPRT) drawing files - Save time and effort for your system volumetric analysis design. Includes jpg file previews. Please go to download at <http://www.digitalview.com/products/HX-4096-lcd-controller>

The maximum thickness of the controller is 18.93mm with or without video add-on board (measured from bottom of PCB to top of components, including any underside components & leads). We recommend clearances of:

- 5mm from bottom of PCB - if mounting on a metal plate we also recommend a layer of suitable insulation material is added to the mounting plate surface.
- 10mm above the components
- 3~5mm around the edges

Any of the holes shown above can be used for mounting the PCB, they are 3.2mm in diameter.

CAUTION: Ensure adequate insulation is provided for all areas of the PCB with special attention to high voltage parts such as the inverter.

APPLICATION NOTES

USING THE CONTROLLER WITHOUT BUTTONS ATTACHED

This is very straightforward:

- Firstly setup the controller/display system with the buttons. With controls attached and display system active make any settings for color, tint and image position as required then switch everything off.
- Remove the control switches, the 12-way (CNC1) cable.
- Use a jumper or similar to connect pins 1 & 2 on JP6, this will fix the board On.
- Refer to inverter specifications for details as to fixing brightness to a desired level, this may require a resistor, an open circuit or closed circuit depending on inverter.

Summary: On CNC1 the only pins that are used are for On/Off and Brightness (if controller mounted inverter is used). On CNC1 the pins are for momentary type buttons so it doesn't matter that no buttons are attached.

INVERTER CONNECTION

There are potentially 3 issues to consider with inverter connection:

- Power
- Enable
- Brightness

Please read the following sections for a guide to these issues.

Inverter Power: As per the table for CNB1 pin 1 is ground and pin 2 provides 12V/24V DC. This should be matched with the inverter specification: see table.

CNB1

PIN	DESCRIPTION
1	Ground
2	+12V/+24VDC

Remark: For higher power inverter, more current (for 12V/24V) can be taken from CNA1 pin 1.

Enable: This is a pin provided on some inverters for On/Off function and is used by this panel controller for VESA DPMS compliance. If the inverter does not have an enable pin or the enable pin is not used then DPMS will not be operational. Pin 3 should be matched to the inverters specification for the 'enable' or 'disable' pin.

CNB1

PIN	DESCRIPTION
3	Enable

Further, jumpers JB2 & JB3 should be set to match the inverters specification for the enable pin power and High or Low setting: see table.

Ref	Purpose	Note
JB2	Inverter enable voltage	1-2 H = 3.3V, 2-3 H = 5V, OPEN H = open collector
JB3	Inverter control	1-2 H = On, 2-3 L = On

Brightness: There are various methods for brightness control and it is important to consider the specifications for the inverter to be used. Generally the situation is:

- Brightness can control by using a resistor or VR (Variable Resistor).
- Brightness controlled by adding a circuit such as PWM (Pulse Width Modulation).
- No adjustment of brightness is possible.

CNB1 pins 4 & 5 are available for connecting to an inverter or circuit where VR control is supported.

CNB1

PIN	DESCRIPTION
4	VR WIP
5	VR A

This can then be matched with function controls connected to CNC1 pins 4 & 3 or 5: see table.

CNC1

PIN	DESCRIPTION
3	VR A
4	VR WIP
5	VR B

Design Guideline for making VR circuitry :

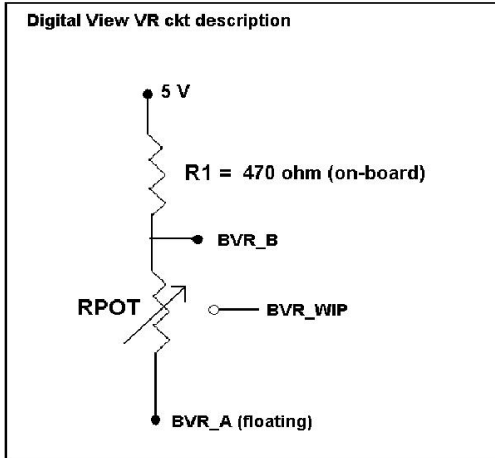

Signal description / Notes :

- 1) R1 : 470ohm on board
- 2) RPOT is an external potentiometer (in-line dip style) that can be plugged directly into CNC1 pins 3,4,5. RPOT must be supplied / installed by user.
- 3) BVR_B : Voltage tapped from “top” of potentiometer, the node of R1 and RPOT.
- 4) BVR_WIP : Voltage tapped from wiper arm of RPOT.
- 5) BVR_A : Voltage tapped from “bottom” of RPOT.

Note : BVR_A voltage is left floating on the controller board. To use this circuit, you need to tie this point to a potential (usually GND, available at CNC1 pin 6).

CNB1 – Backlight inverter connector: JST B5B-XH-A (Matching type : XHP-5)

PIN	SYMBOL	DESCRIPTION
1	GND	Ground
2	VBKL	+12V/24VDC, backlight power supply
3	BLCTRL	On/Off control (enable) – see JB2 & JB3
4	BVR_WIP	Brightness VR - WIP
5	BVR_A	Brightness VR A

CNC1 – OSD switch mount control, Hirose DF13A-12P-1.25H (Mating type : DF13-12S-1.25C)

PIN	SYMBOL	DESCRIPTION
1	PSWIN	Power button A
2	SW_ON	Power button B
3	BVR_A	Backlight Brightness VR pin A
4	BVR_WIP	Backlight Brightness R pin WIP
5	BVR_B	Backlight Brightness VR pin B (470 ohm resistor to +5V Vcc)
6	GND	Ground
7	MENU	OSD menu
8	-/LEFT	OSD -/Left
9	+/RIGHT	OSD +/Right
10	SEL_DN	OSD Select down
11	SEL_UP	OSD Select up
12	NC	No connection

The VR for brightness depends on the inverter. The main power load for On/Off is handled by a relay on the controller.

Example for circuit design :

- 1.) Choose RPOT = 10K
- 2.) Tie BVR_A to GND
- 3.) Circuit analysis gives BVR_WIP as the following (see Figure 1)

$$BVR_WIP = 5 \times (Rbc/10.47)$$

where BVR_WIP is in Volts.
And Rbc is the resistance from the wiper arm to bottom of pot in Kohms.

To evaluate, plug in different values of Rbc :

Rbc	BVR_WIP
0	0 V
2.5 K	1.2 V
5 K	2.4 V
7.5 K	3.6 V
10 K	4.8 V

So this circuit could provide Brightness adjust voltage ranging from 0V to 5V.

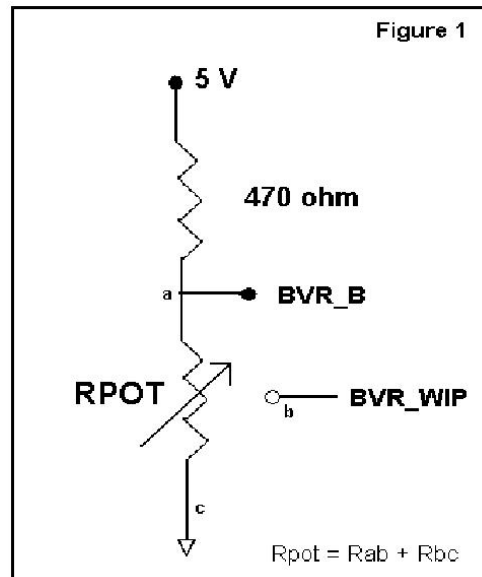

TROUBLESHOOTING

General

A general guide to troubleshooting a flat panel display system it is worth considering the system as separate elements, such as:

- Controller (jumpers, PC settings)
- Panel (controller, cabling, connection, panel, PC settings)
- Backlight (inverter, cabling, backlight tubes)
- Cabling
- Computer system (display settings, operating system)

Through step by step cross checking with instruction manuals and a process of elimination to isolate the problem it is usually possible to clearly identify the problem area.

No image:

- If the panel backlight is not working it may still be possible to just see some image on the display.
- A lack of image is most likely to be caused by incorrect connection, lack of power, failure to provide a signal or incorrect graphic card settings.

Image position:

If it is impossible to position the image correctly, i.e. the image adjustment controls will not move the image far enough, then test using another graphics card. This situation can occur with a custom graphics card that is not close to standard timings or if something is in the graphics line that may be affecting the signal such as a signal splitter (please note that normally a signal splitter will not have any adverse effect).

Image appearance:

- A faulty panel can have blank lines, failed sections, flickering or flashing display
- Incorrect graphics card refresh rate, resolution or interlaced mode will probably cause the image to be the wrong size, to scroll, flicker badly or possibly even no image.
- Incorrect jumper settings on the controller may cause everything from total failure to incorrect image. CAUTION: Do not set the panel power input incorrectly.
- Sparkling on the display: faulty panel signal cable.

Backlight:

Items to check include: Power input, Controls, Inverter and Tubes generally in this order.

If half the screen is dimmer than the other half:

- Check cabling for the inverter.
- For a specific backlight tube check the AC pins orientation (CAUTION: Never reverse any DC power pins).

Also:

- If adjusting brightness control has no effect the chances are that the VR rating or method of adjusting brightness is not compatible or correctly connected to the inverter.
- If system does not power down when there is a loss of signal

Continued failure:

If unit after unit keeps failing consider and investigate whether you are short circuiting the equipment or doing something else seriously wrong.

Generally after common sense issues have been resolved we recommend step by step substitution of known working parts to isolate the problem.

The following are some of LED indicators onboard that can help to know the health status of the controller board:

LED1A

- Green : Valid video signal received on the selected input port.
- Red : No video signal received on the selected input port.
- Green + Red : The board is fail to boot up. Suggest to send it back to factory for check.
- Off : The board is not powered on.

LED2

- Red : +10V / +12V / +18V power is supplied to panel.
- Green : +3.3V / +5V power is supplied to panel.
- Off : No power is supplied to panel.

D1 (for V-by-One panel only)

- Green : V-by-One's LOCKN signal is set LOW by panel when CDR (clock data recovery) taining is done and CDR is locked.
- Off : No V-by-One's signal is detected and locked.

SPECIFICATIONS

Panel compatibility	Compatible with 4096x2160 resolutions of TFT LCD panels with V-by-One /eDP/LVDS panel interface. A specified BIOS and some factory adjustment is required for individual panel timings.
No. of colors	Up to 3 x 10 bit providing 1.06 billion colors.
Panel power	DC 3.3V, 5V, 10V, 12V, 18V
Panel signal	V-by-One (8 Lane) eDP (1.1 HBR) / (1.2 HBR2) LVDS (8 channel)
Video inputs	DVI-I (Dual Link) Display Port 1.2 HDMI 1.4 HDMI 2.0
Functions display	On screen display (OSD) of functions
OSD menu functions	Image controls: Panel brightness/contrast, Saturation, Hue, Color temperature, Sharpness, Aspect ratio, Rotate, Gamma, PIP/PBP.
OSD menu controls available	Power On/Off OSD Menu OSD Select up OSD Select down Setting + Setting -
Control interface	Buttons, RS-232, IR Remote control, Ethernet control
Audio	Digital audio line out (from header) with OSD volume control. (not amplified)
Settings memory	Settings are stored in non volatile memory
PC Connectivity	VGA / SVGA / XGA / SXGA / UXGA / WUXGA analog or digital
Controller dimensions	203.2mm x 154mm (8" x 6.06")
Power consumption	10W approx. (not including panel power consumption)
Power load maximum	The controller has an overall 3Amp current limit.
Input voltage	12V/24VDC +/- 5%
On board battery lifetime	3 years at storage (without applying power to the unit). The battery is not rechargeable.
Power protection	Fuse fitted (Resettable)
DC Power handling	Reverse power polarity protection is equipped on the board
Storage temperature limits	-40°C to +85°C
Operating temperature limits	0°C to +80°C
Use of memory on board	<p>Volatile memory</p> <ul style="list-style-type: none"> - 64KB SRAM (Parameters settings) - 128KB SRAM (OSD) - 1Gb SDRAM (Video buffer) <p>Non-Volatile memory</p> <ul style="list-style-type: none"> - 512KB Flash (Program data) - 12KB Flash (Parameters settings) - 16Mb Flash (System program) - 2Mb Flash (Web page data) - 512KB EEPROM (System settings)

Specifications subject to change without notice

	- 2Kb EEPROM (Video input parameters)
--	---------------------------------------

NOTES

Please note the following:

- For specific panel setup a sample of an LCD may be required (this will be returned) and a copy of the full technical specifications for the panel from the manufacturer.
- Re-layout and custom development services are available.

APPENDIX I – SIGNAL SUPPORT MODE TABLE**ARGB input port (P1) :**
(with DVI to VGA adapter)

Resolution
640x480 60Hz
640x480 75Hz
800x600 56Hz
800x600 60Hz
800x600 72Hz
800x600 75Hz
1024x768 60Hz
1024x768 70Hz
1024x768 75Hz
1280x768 60Hz
1280x768 75Hz
1280x1024 60Hz
1280x1024 75Hz
1360x768 60Hz
1440x900 60Hz
1600x900 60Hz
1600x1200 60Hz
1680x1050 60Hz
1920x1080 60Hz
1920x1200 60Hz

DVI input port (P1) :

Resolution
640x480 60Hz
640x480 75Hz
800x600 56Hz
800x600 60Hz
800x600 72Hz
800x600 75Hz
1024x768 60Hz
1024x768 70Hz
1024x768 75Hz
1280x768 75Hz
1280x800 75Hz
1280x1024 60Hz
1280x1024 75Hz
1360x768 60Hz
1366x768 60Hz
1440x900 75Hz
1600x1200 75Hz
1680x1050 75Hz
1920x1080 60Hz
1920x1200 60Hz
2560x1600 60Hz
3840x2160 30Hz

HDMI 1.4 input port (P2 / P3) :

Resolution
640x480 60Hz
640x480 72Hz
640x480 75Hz
800x600 56Hz
800x600 60Hz
800x600 72Hz
800x600 75Hz
1024x768 60Hz
1024x768 70Hz
1024x768 75Hz
1280x768 60Hz
1280x768 75Hz
1280x800 60Hz
1280x800 75Hz
1280x1024 60Hz
1280x1024 75Hz
1360x768 60Hz
1366x768 60Hz
1440x900 75Hz
1600x1200 75Hz
1680x1050 75Hz
1920x1080 60Hz
1920x1200 60Hz
2560x1600 60Hz
3840x2160 30Hz

HDMI 2.0 input port (P4) :

Resolution
640x480 60Hz
640x480 72Hz
640x480 75Hz
800x600 56Hz
800x600 60Hz
800x600 72Hz
800x600 75Hz
1024x768 60Hz
1024x768 70Hz
1024x768 75Hz
1280x768 60Hz
1280x768 75Hz
1280x800 60Hz
1280x800 75Hz
1280x1024 60Hz
1280x1024 75Hz
1360x768 60Hz
1366x768 60Hz
1440x900 75Hz
1600x1200 75Hz
1680x1050 75Hz
1920x1080 60Hz
1920x1200 60Hz
2560x1600 60Hz
3840x2160 30Hz
3840x2160 60Hz
4096x2160 60Hz

Display port 1.2 input port (P5) :

Resolution
640x480 60Hz
640x480 72Hz
640x480 75Hz
720x480 60Hz
720x576 50Hz
800x600 56Hz
800x600 60Hz
800x600 72Hz
800x600 75Hz
1024x768 60Hz
1024x768 70Hz
1024x768 75Hz
1280x768 60Hz
1280x800 60Hz
1280x1024 60Hz
1280x1024 75Hz
1366x768 60Hz
1400x1050 60Hz
1440x900 60Hz
1600x900 60Hz
1600x1200 60Hz
1680x1050 60Hz
1920x1080 60Hz
1920x1200 60Hz
2560x1600 60Hz
3840x2160 30Hz
3840x2160 60Hz
4096x2160 60Hz

Appendix II – Network connection

The HX-4096 LCD interface controller has an RJ-45 Ethernet port for control and monitoring over a network. This application note introduces the two user interface modes:

- Command line direct mode
- Browser based web server mode

Before enter the above modes, make sure the Network option has been enabled in OSD menu settings. On OSD menu, go to “Advanced” -> “Communication” -> “Network” -> Press Down key to select and confirm. See below:

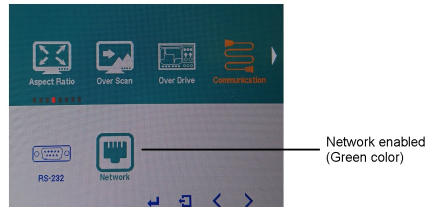

QUICK GUIDE

For experienced users the following quick guide to trying out the network connection and functions may be useful.

Command line direct mode: The RS-232 commands available are the same as documented in Appendix III and writing a control application is very similar to the RS-232 type except the commands must pass through the network. An alternative is to use an application written for RS-232 communication and use a virtual serial port program such as “TCP-COM” (<http://www.taltech.com/products/tcpcom.html>)

This software can create “Virtual” RS-232 serial ports that are actually connections to a TCP/IP port. This allows you to use existing Windows based serial communications software to send and receive data across TCP/IP network. (Note: The 3rd party program is not warranted nor is it the responsibility of Digital View.)

Below are the example of using TCP-COM and serial communication software (e.g. Access Port) to adjust brightness value of HX-4096 over LAN.

1. Open the “TCP-Com” program and set the following settings and then click activate.

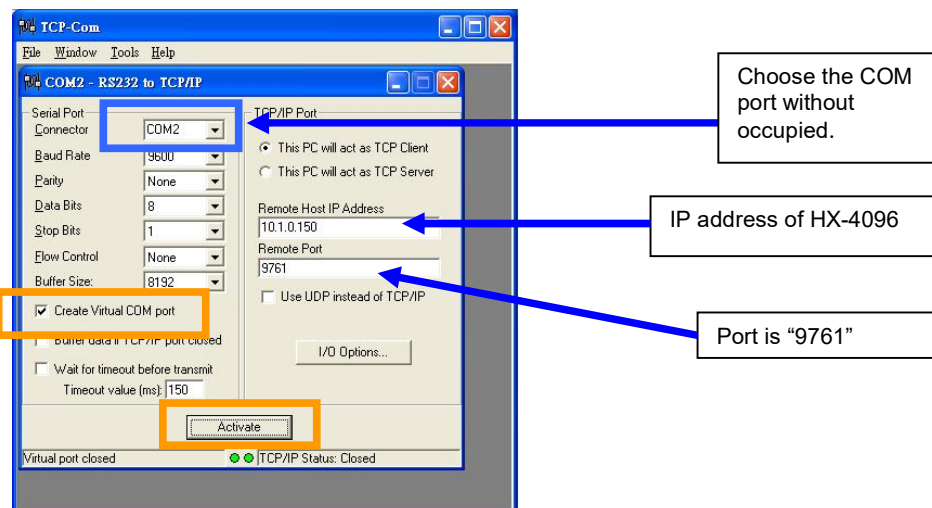

- Open "AccessPort" serial communication software. Tick "Port Switch" and then go to "Tool" → "Configuration" to follow the settings stated below :

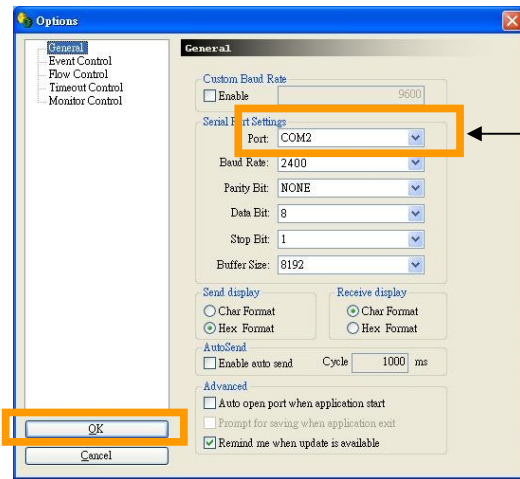
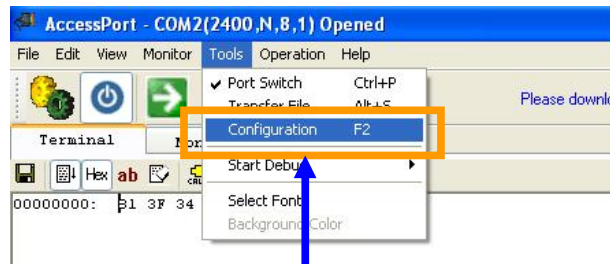

Choose COM port same as TCP-COM

- Start to type RS-232 command under serial communication program (e.g AccessPort) to control the HX-4096.

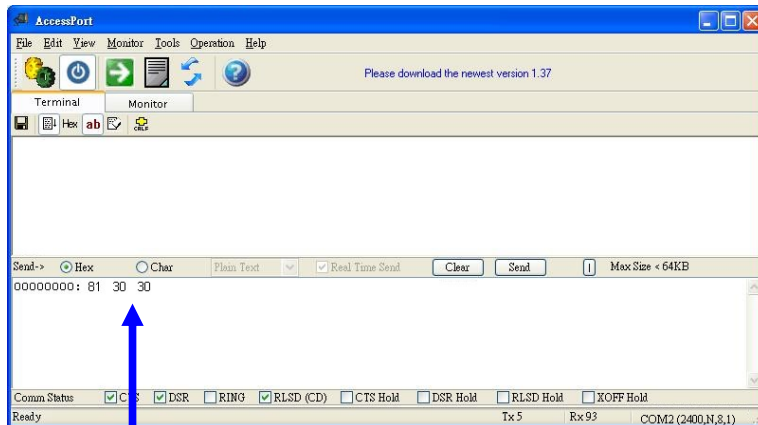

For example : Type "81 30 30" to adjust Brightness to min value. (0%)

Some command examples:

- C8 30 [Soft power off]
- C8 31 [Soft power on]
- 81 36 34 [Adjust brightness to max. value]
- 98 50 31 [Jump to Display Port input]

Browser based web server mode :

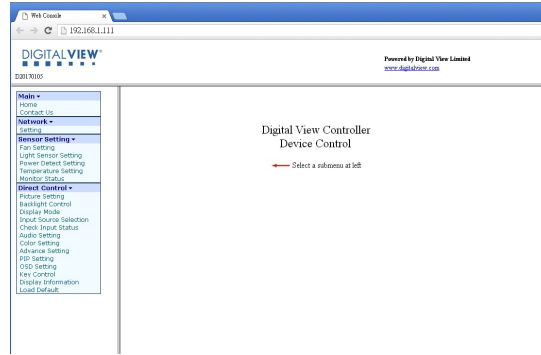

- Works with a normal network with DHCP, i.e. must use a router on LAN.
- Connect the HX-4096 to the LAN network and ensure power is on.
- Use the IP Locator utility available from the IP-60 web-page. <http://www.digitalview.com/media/downloads/IPLocator.zip> (Windows only)
- Double click on the IP address in the IP Locator window, it will open the HX-4096 browser page in your default browser. Alternatively copy the IP address into your browser address line.
- Test the functions that come up on the browser. The function list on browser can be found in Appendix VII. (Some sensor functions might require alternative firmware version.)

For details, please refer to the separate application note.

Appendix III – RS-232 control protocols and command set

RS-232 Serial control (Baud rate 2400), 8 bits, 1 stop bit and no parity

Physical connection :

Controller side
Connector interface : CN8
Mating connector : JST XHP-6

Computer side
Connector interface : Serial port
Mating connector : DB9 Female

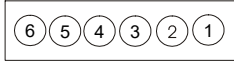

Mating face of CN8

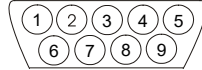

Mating face of RS-232 DB9 Male

PIN#	Description
4	RS-232 Tx Data
5	Ground
6	RS-232 Rx Data

PIN#	Description
2	RS-232 Rx Data
3	RS-232 Tx Data
5	Ground

Remark :

(1) : RS-232 connection cable, 600mm P/N 426090200-3 can be ordered separately for connection.

Software connection :

The OSD function can be controlled through sending the RS-232 protocol.

The RS-232 program can be custom-made to fit for application or it can be used the serial control program, like Accessport, Telix or Serial Utility program developed by DigitalView. Please contact your local support for information.

1. Commands to implement switch mount control buttons

Function	Command	Description	Remark
Menu button	0xf7	Menu button pressed	Button equivalent
Select-down button	0xfa	Select-down button pressed	Button equivalent
Select-up button	0xfb	Select-up button pressed	Button equivalent
Right/+ button	0xfc	Right/+ button pressed	Button equivalent
Left/- button	0xfd	Left/- button pressed	Button equivalent

2. Parameter setting - immediate, relative, reset and query

Function	Command	Description	Acknowledge (if enabled)
Volume control - left+right channel	0x80, "a" "A", nn "+" "-" "r" "R" "?"	Set audio (L+R) volume = value/increment/decrement Reset Query	nn = 0x00~ 0x64 (0~100%) Default: 0x32 (50%)
Volume control - on/off (mute)	0x80, "m" "M", "0" "1" "r" "R" "?"	Disable audio output. Enable audio output. Reset Query	"0" - audio off (mute). "1" - audio on. (Default)
Audio selection	0x80, "P", "n" "?" "r" "R"	Select Audio Output Query Reset	"n" = "0" - P1 (upper left picture) (Default) "1" - P2 (lower left picture) "2" - P3 (upper right picture) "3" - P4 (lower right picture) "A/a" – Analog source Note: P1~P4 audio source is available when video source is either DP or HDMI
Brightness control	0x81, nn "+" "-" "r" "R" "?" "m" "n"	Set brightness = value/increment/decrement Reset Query Current Source Maximum query Minimum query	nn = 0x00~ 0x64 (0~100%) Default: 0x32 (50%)
Contrast control	0x82, "a" "A", nn "+" "-" "r" "R" "?" "m" "n"	Set contrast = value/increment/decrement Reset Query Maximum query Minimum query	nn = 0x00~ 0x64 (0~100%) Default: 0x32 (50%)
Color saturation control	0x83, nn "+" "-" "r" "R" "?" "m" "n"	Set color saturation = value/increment/decrement Reset Query Maximum query Minimum query	nn = 0x00~ 0x64 (0~100%) Default: 0x32 (50%)
Hue control	0x84, nn "+" "-" "r" "R" "?" "m" "n"	Set tint = value/increment/decrement Reset Query Maximum query Minimum query	nn = 0x00~ 0x64 (0~100%) Default: 0x32 (50%)
Phase control (only for VGA port)	0x85, nn "+" "-" "?"	Set phase = value/increment/decrement Query	nn = 0x00~ 0x64 (0~100%)
Image H position	0x86,	Set horizontal position =	nn = 0x00~ 0x64 (0~100%)

Specifications subject to change without notice

(only for VGA port)	nn "+" "-" "r" "R" "?"	value/increment/decrement Reset Query	
Image V position (only for VGA port)	0x87, nnnn "+" "-" "r" "R" "?"	Set vertical position = value/increment/decrement Reset Query	nn = 0x00~ 0x64 (0~100%) Default: 0x32 (50%)
Sharpness	0x8a, n "+" "-" "r" "R" "?"	Set sharpness = value/increment/decrement Reset Query	nn = 0x00~ 0x64 (0~100%) Default: 0x32 (50%)
Clock control (only for VGA port)	0x8b, nn "+" "-" "?"	Set VGA clock= Value/increment/decrement Query	nn = 0x00~ 0x64 (0~100%)
Aspect Ratio	0x8c, "0" "1" "9" "A" "F" "r" "R" "?"	Set video aspect ratio= Value Reset Query	"0" – 1:1 "1" – fill screen (Default) "9" – 4:3 "A" – 16:9 "F" – 5:4
Set display orientation	0x8e, n "r" "R" "?"	Set display orientation = value Reset Query	"0" – normal (0 degree) (Default) "4" – rotated 90 "5" – rotated 180 "6" – rotated 270 Note: Rotation is only allowed in 1P mode
Rotate OSD	0x8f, "0" "1" "3" "?"	Normal OSD rotate rotated 90 rotated 270 Query	"0" – normal OSD. (Default) "1" – rotated 90 OSD. "3" – rotated 270 OSD.
OSD H position	0x90, nn "+" "-" "r" "R" "?"	Set OSD horizontal position = value/increment/decrement Reset Query	nn = 0x00~ 0x64 (left ~ right) Default: 0x32 (middle)
OSD V position	0x91, nn "+" "-" "r" "R" "?"	Set OSD vertical position = value/increment/decrement Reset Query	nn = 0x00~ 0x64 (top ~ bottom) Default: 0x32 (middle)
OSD transparency	0x92, nn "+" "-" "r" "R" "?"	Set OSD transparency = value/increment/decrement Reset Query	nn = 0x00~ 0x64 (0~100%) Default: 0x00 (No transparency)
OSD menu timeout	0x93, nn "+" "-" "r" "R" "?"	Select menu timeout = value/increment/decrement Reset Query	OSD menu timeout value. nn = 0x0A – Always on nn = 0x0B - 0x3C (11~60sec) Default: 0x0B (11sec)
Input main video (P1) select	0x98, nn "+" "-" "r" "R" "?"	Select P1 video input = value/next input/previous input Reset Query	"nn" = "0x41,0x31" A0: VGA "0x50, 0x31" D0: DP (Default) "0x48,0x31" D1: HDMI "0x48,0x32" D2: HDMI "0x48,0x33" D3: HDMI "0x45,0x31" D3: HD-SDI (for custom code only) "0x46,0x31" D4: DVI
Auto source seek	0x99, "0" "1" "r" "R" "?"	Set auto source seek = Disable/Enable Reset Query	Default: "1" (Enable)

Source Layout	0x9a, n "r" "R" "?"	Select video source layout = Single, PIP, PBP, 4P Reset, Query	"n": "0"- 1P (Single) (Default) "1"- 2P PIP "2"- 2P PBP (Left Right) "3"- 2P PBP (Top Bottom) "4"- 4P
GAMMA value select	0x9d, n "r" "R" "?"	Select GAMMA value = Value Reset Query	"n": "5" - 1.8, "7" - 2.0, "2" - 2.2, (Default) "A" - 2.4
Auto power off	0x9f, "0" "1" "r" "R" "?"	Set auto power save option = Disable/Enable Reset Query	"n": "0" - Disable auto power off "1" - Enable auto power off (Default)
Hot key 1 (plus and minus keys)	0xa0, "1", n "r" "R" "?"	Set Hot key 1= Value Reset Query	"n": "1" - volume "2" - brightness "3" - contrast "4" - color saturation "5" - input source (P1 source) "9" - PIP size "B" - No hot key function (Default) "D" - PIP Swap "E" - Aspect ratio "G" - Hue "H" - Backlight level "I" - VGA Auto picture adjust "L" - Sharpness "M" - Display mode (select 1P, 2P PIP, 2P PBP or 4P)
Hot key 2 (up and down keys)	0xa0, "2", n "r" "R" "?"	Set Hot key 2= Value Reset Query	"n": "1" - volume "2" - brightness "3" - contrast "4" - color saturation "5" - input source (P1 source) "9" - PIP size "B" - No hot key function (Default) "D" - PIP Swap "E" - Aspect ratio "G" - Hue "H" - Backlight level "I" - VGA Auto picture adjust "L" - Sharpness "M" - Display mode (select 1P, 2P PIP, 2P PBP or 4P)
Runtime counter	0xa1, nnnnn "r" "R" "?"	Set runtime counter value = nnnnn (* 0.5 hour) Reset to zero Query	Runtime = nnnnn. Max. input = 0x1fff (0x1ffe * 0.5 hour = 65535 hours) Runtime counter counts when backlight is on
PIP H position	0xa4, nn "+" "-" "r" "R" "?"	Set PIP horizontal position= value/go right/go left Reset Query	PIP window horizontal position. nn: 0x00(left)~0x64(right) Default: 0x64
PIP V position	0xa5, nn "+" "-" "r" "R" "?"	Set PIP vertical position= value/go down/go up Reset Query	PIP window vertical position. nn: 0x00(top)~0x64(bottom) Default: 0x64
PIP window size select	0xa6, nn "r" "R"	Select PIP window size = PIP window size value Reset	nn: 0x00(smallest)~0x0A (largest) Default: 0x0A

Specifications subject to change without notice

	"?"	Query	
PIP /P2 source select	0xa7, nn "r" "R" "?"	Select PIP or P2 video source = Video source value Reset Query	P2 is: 2P PBP left right: right window 2P PBP top bottom: bottom window 4P: lower left window "nn" = "0x41,0x31" A0: VGA "0x50,0x31" D0: DP "0x48,0x31" D1: HDMI (Default) "0x48,0x32" D2: HDMI "0x48,0x33" D3: HDMI "0x45,0x31" D3: HD-SDI (for custom code only) "0x46,0x31" D4: DVI Please note that PIP or PBP mode should be enabled first before select video source.
P3 source select	0xa7, "c" nn "r" "R" "?"	Select P3 video source = Video source value Reset Query	P3 is upper right window in 4P mode "nn" = "0x41,0x31" A0: VGA "0x50,0x31" D0: DP "0x48,0x31" D1: HDMI "0x48,0x32" D2: HDMI (Default) "0x48,0x33" D3: HDMI "0x45,0x31" D3: HD-SDI (for custom code only) "0x46,0x31" D4: DVI Please note that 4P PBP mode should be enabled first before select video source.
P4 source select	0xa7, "d" nn "r" "R" "?"	Select P4 video source = Video source value Reset Query	P4 is lower right window in 4P mode "nn" = "0x41,0x31" A0: VGA "0x50,0x31" D0: DP "0x48,0x31" D1: HDMI "0x48,0x32" D2: HDMI "0x48,0x33" D3: HDMI (Default) "0x45,0x31" D3: HD-SDI (Default, for custom code only) "0x46,0x31" D4: DVI Please note that 4P PBP mode should be enabled first before select video source.
Colour temperature select	0xb3, n "r" "R" "?"	Select colour temperature = value Reset Query	"n" = "2" – 6500K. (Default) "4" – User "5" – 9300K "6" – 7500K "7" – 5800K "8" – sRGB "9" – 3200K "A" – 2600K (custom code)
Red level of User colour temperature	0xb4, nn "+" "-" "r" "R"	Set the level of the red channel for the user colour temp. = value/increment/decrement Reset	nn: 0x00~ 0xff (0~255) Default: 0x80

	“?” “m” “n”	Query Maximum query Minimum query	
Green level of User colour temperature	0xb5, nn “+” “-” “r” “R” “?” “m” “n”	Set the level of the green channel for the user colour temp. = value/increment/decrement Reset Query Maximum query Minimum query	nn: 0x00~ 0xff (0~255) Default: 0x80
Blue level of User colour temperature	0xb6, nn “+” “-” “r” “R” “?” “m” “n”	Set the level of the blue channel for the user colour temp. = value/increment/decrement Reset Query Maximum query Minimum query	nn: 0x00~ 0xff (0~255) Default: 0x80
Video horizontal resolution enquiry	0xb7	Horizontal resolution (in pixels) in 3 to 4 digit hex number	
Video vertical resolution enquiry	0xb8	Vertical resolution (in lines) in 3 digit hex number	
Video horizontal sync frequency	0xb9	Horizontal sync frequency (in units of 100Hz) in 3 digit hex number	
Video vertical sync frequency	0xba	Vertical sync frequency (in units of Hz) in 3 digit hex number and 1 char	“nnnc” = vertical frequency nnn = 3 digit hex c= “i” (interlace) or “p” (progressive)
OSD status enquiry	0xbb	Status of OSD	“0” – OSD turned off “1” – OSD turned on
Display video information box	0xbc, “?” “0” “1”	Query No video info box shown After switching to a new video source, the video info box is displayed for 5 seconds.	“0” – disabled. “1” – enabled. (Default)
OSD turn off	0xbd	Turn off the OSD.	“0” – fail. “1” – successful.
Backlight control	0xe0, nn “+” “-” “R” “r” “?”	Set Backlight level = value/increment/decrement Reset Query	nn = 0x00~ 0x64 (0~100%) Default: 0x64 (100%)
Backlight On/Off	0xe1, “0” “1” “R” “r” “?”	Backlight Off / Backlight On Reset Query	“0” – Backlight Off “1” – Backlight On. (Default)
Swap PIP / 2P PBP video source	0xe3	Swap Main and PIP Source (PIP mode), left & right source (PBP LR) or Top & Bottom (PBP TB)	“0” – fail. “1” – successful.
Backlight DA/PWM	0xe5 “0” “1” “R” “r” “?”	Set backlight control method: PWM / DA Reset Query	“0” – PWM (Default) “1” – D/A
Backlight PWM frequency	0xe6, nnn “+” “-” “R” “r” “?”	Set backlight PWM frequency = value/increase 20Hz/decrease 20Hz Reset Query	Value 100Hz : “0”, “6”, “4” 120Hz : “0”, “7”, “8” 140Hz : “0”, “8”, “C” 160Hz : “0”, “A”, “0” (Default) 180Hz : “0”, “B”, “4” 200Hz : “0”, “C”, “8”

			220Hz : "0", "D", "C" 240Hz : "0", "F", "0" 260Hz : "1", "0", "4" 280Hz : "1", "1", "8" 300Hz : "1", "2", "C" 320Hz : "1", "4", "0" 340Hz : "1", "5", "4" 360Hz : "1", "6", "8" 380Hz : "1", "7", "C" 400Hz : "1", "9", "0" 420Hz : "1", "A", "4" 440Hz : "1", "B", "8"
Backlight Invert	0xe7 "0" "1" "R" "r" "?"	Set invert backlight level : Off / On Reset Query	"0" – Off (Default) "1" – On
PIP window transparency Level	0xed, nn "+" "-" "R" "r" "?"	Select PIP transparency level = value/increase/decrease Reset Query	nn: 0x00~0x0A (no ~ total transparency) Default: 0x00
Minimum backlight level	0xee, "0x5C" nn "+" "-" "R" "r" "?"	Set minimum backlight level= value/increment/decrement Reset Query	Minimum Backlight value. nn: 0x00 ~ 0x32 (0~50%) Default: 5%
OSD switch mount Lock	"0xee", "0x62" "0" "1" "?"	Unlock / Lock Query	"0"- Unlock (Default) "1"- Lock, no response to OSD switch mount keys
Default Power	"0xee", "0x6B", "0x50" "0" "1" "?"	Default power state after supplying power to controller Off On Query	"0" - default power off "1" - default power on
Color Effect	"0xee", "0x71", "0x30" "0" "1" "2" "3" "4" "5" "?" "r" "R"	Select Color Effect Value Query Reset	"0" = Standard (Default) "1" = Game "2" = Movie "3" = Photo "4" = Vivid "5" = User
Vby1 pin setting	"0xee", "0x73", 0x30 0x31 ... 0x39, "0" "1"	Set Vby1 pin state Pin no.: 0x30=pin15, 0x31=pin16,..., 0x39=pin24 Pin logic level	"0" = set to low (Default) "1" = set to high
Panel timing setting	"0xee", "0x74", 0x30, nnn 0x31, nnn 0x32, nnn 0x33, n 0x34, n 0x35, n 0x36, nnnn 0x37, nnnn 0x38, nnnn	Panel timing setting 0x30= typical frame rate 0x31= max frame rate 0x32= min frame rate 0x33= panel style 0x34= eDP phy rate 0x35=LVDS/Vx1 output ports 0x36=Hsync back porch 0x37=Display horizontal width 0x38=Vertical total typical	Set panel timing to SRAM of HX-4096. If cmd 2 nd parameter is n = 0x3F, it dumps the values of SRAM Please note "n" is BCD decimal value in ASCII. e.g. 610 is set as 0x36 0x31 0x30 1=Lvds, 3=Vx1, 4=eDP1.1, 5=eDP1.2 1=HBR, 2=HBR2 0=1ports, 1=2ports, 2=4ports, 3=8ports

	0x39, nnnn 0x3A, nnnn 0x3B, nnnn 0x3C, nnnn 0x3D, nnnn 0x3E, nnnn 0x3F, nnnn 0x40, nn 0x41, nn 0x42, nnn 0x43, nnn 0x44, nnn 0x45, nnnn 0x46, nnnn 0x47, nnnn 0x48, nnnn 0x49, nnnn 0x4A, nnnn 0x4B 0x4C 0x57	0x39=Vertical total max 0x3A=Vertical total min 0x3B=Vsync back porch 0x3C=Display vertical height 0x3D=Horizontal total typical 0x3E=Horizontal total max 0x3F=Horizontal total min 0x40=Hsync width 0x41=Vsync height 0x42 = Pixel clock typical 0x43 = Pixel clock max 0x44 = Pixel clock min 0x45 = Panel power on time T1 0x46 = Panel power on time T2 0x47 = Panel power on time T3 0x48 = Panel power off time T4 0x49= Panel power off time T5 0x4A = Panel power off time T6 Read all panel timing checksum Read all panel timing parameter Write all panel timing parameters from SRAM into EEPROM	 in MHz in MHz in MHz in ms in ms in ms in ms in ms in ms in ms checksum, which is found by adding values of parameter 0x30 to 0x4A Read all parameters from SRAM and dump each timing starting with 0xEE 0x74 0xYY nnnn to facilitate saving dump data to file for send back to HX-4096 later "1": Success "0": Fail
User EDID	"0xee", "0x76", "nn",	Command Select Port	"nn" = "0x41,0x31" A0: VGA "0x50, 0x31" D0: DP "0x48,0x31" D1: HDMI "0x48,0x32" D2: HDMI "0x48,0x33" D3: HDMI "0x45,0x31" D3: HD-SDI (custom code) "0x46,0x31" D4: DVI
EDID Block map for blocks 0 – 128	"S" "s" "n,n+1....(256 BYTE) "	Send 128 BYTE EDID in ASCII Code Format (256BYTE)	return "1" Success return "0" Fail
EDID Block map for blocks 129 – 254 if more than 128 blocks used	"E" "e" "n,n+1....(256 BYTE) "	Send 128 BYTE EDID in ASCII Code Format (256BYTE)	return "1" Success return "0" Fail
Reset	"R" "r"	Reset to use pre-defined EDID instead of user EDID of selected port	return "1" Success return "0" Fail

3. Other control

Function	Command	Description	Acknowledge (if enabled)
Select RS-232 acknowledge	0xc1, "0" "1"	Disable/enable command acknowledge.	"0" – acknowledge disabled. "1" – acknowledge enabled. (Default)
VGA auto adjust	0xc3	Start VGA auto adjust	"0" – fail. "1" – successful.
Command availability	0xc4, nn / nnnn	Check whether a command is available.	"0" – not available. "1" – available. e.g "0x81" command send "0xc4 0x38 0x31" feedback "0xc4 0x38 0x31 0x31" e.g "0xee 0x5c" command send "0xc4 0x45 0x45 0x35 0x43" feedback "0xc4 0x45 0x45 0x35 0x43 0x31"
VGA auto color gain	0xc5	Start VGA auto-calibration of gain of the RGB amplifier.	"0" – fail. "1" – successful.
Power On/Off	0xc8, "0" "1" "?"	Soft power on/off off/on query	"0" – soft power off. "1" – soft power on.
Query video input status	0xc9	Query the status of the displaying video windows source	Input status nn nn: "0","0" : no video source / disabled "A","1" A0: VGA "F","1" D4: DVI "H","1" D1: HDMI "H","2" D2: HDMI "H","3" D3: HDMI "E","1" D3: HD-SDI (for custom code) "P","1" D0: DP Feedback 4 video windows status in form of: nn nn, nn nn, nn nn, nn nn (P1, P2, P3, P4)
Query BIOS version	0xcb, "0"	Read BIOS version	BIOS version "VV.YY.ZZ" VV = Vx or Ex, (x is version digit) V = Release version E = Engineering Sample YY= Version Number ZZ= Customer Number
Query PCBA number	0xcb, "1"	Read PCBA number	"nnnnn" = PCBA number HX-4096-120= "41759"
Query Revision Number	0xcb, "3"	Read Revision Number	"nn" = Revision number AA in firmware version no. "VV.YY.ZZ.AA"
Reset parameters	0xce	Reset all parameters to default value	"1" – successful.
Reset all parameters	0xcf	Reset all parameters, including user color temperature setting, for all video modes to default value	"1" - successful.

n = 1-byte ascii-coded hex number, e.g., parameter value of 0x1 is represented by "1" (0x31).
 mn or nn = 2-byte ascii-coded hex number, e.g., parameter value of 0x1e is represented by "1", "e" | "E" (0x31, 0x6e|0x4e).

The RS-232 command strings sent in one time can support up to 380 bytes via CN8 port
 The RS-232 command string sent in one time can support up to 50 bytes via CN1 or J1 port.

n = 1-byte ascii-coded hex number, e.g., parameter value of 0x1 is represented by "1" (0x31).
 mn or nn = 2-byte ascii-coded hex number, e.g., parameter value of 0x1e is represented by "1", "e" | "E" (0x31, 0x6e|0x4e).
 Please refer to the ASCII to Hex convert table below.

Hex to ASCII conversion table

Hex	ASCII	Hex	ASCII	Hex	ASCII	Hex	ASCII
0x30	0	0x41	A	0x61	a	0x2B	+
0x31	1	0x42	B	0x62	b	0x2D	-
0x32	2	0x43	C	0x63	c	0x3F	?
0x33	3	0x44	D	0x64	d		
0x34	4	0x45	E	0x65	e		
0x35	5	0x46	F	0x66	f		
0x36	6	0x47	G	0x67	g		
0x37	7	0x48	H	0x68	h		
0x38	8	0x49	I	0x69	i		
0x39	9	0x4A	J	0x6A	j		
		0x4B	K	0x6B	k		
		0x4C	L	0x6C	l		
		0x4D	M	0x6D	m		
		0x4E	N	0x6E	n		
		0x4F	O	0x6F	o		
		0x50	P	0x70	p		
		0x51	Q	0x71	q		
		0x52	R	0x72	r		
		0x53	S	0x73	s		
		0x54	T	0x74	t		
		0x55	U	0x75	u		
		0x56	V	0x76	v		
		0x57	W	0x77	w		
		0x58	X	0x78	x		
		0x59	Y	0x79	y		
		0x5A	Z	0x7A	z		

Appendix IV – Mapping definition

Definition of division

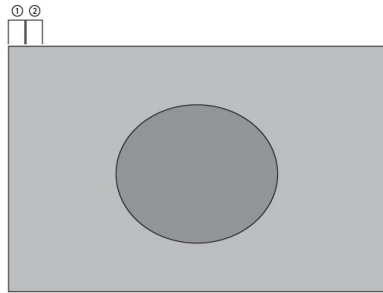

1 Division
(Non-Division)

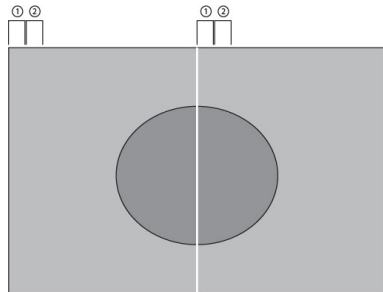

2 Division

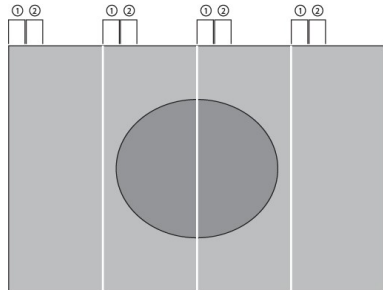

4 Division

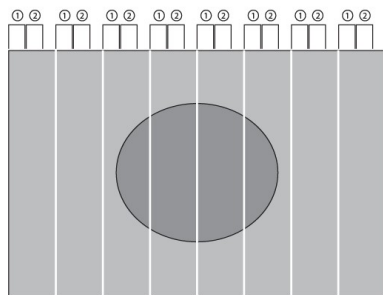

8 Division

Input data mapping

VESA Format (LVDS) (Mapping A)

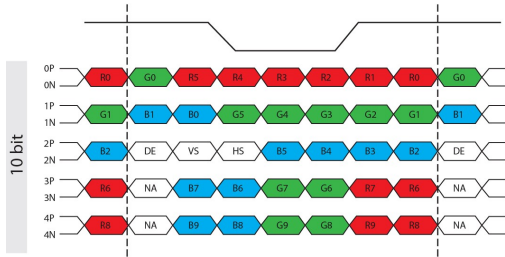

VESA Format (LVDS) (Mapping B)

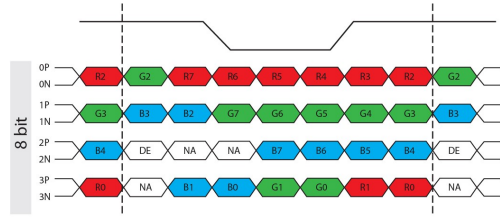

JEIDA Format (LVDS)

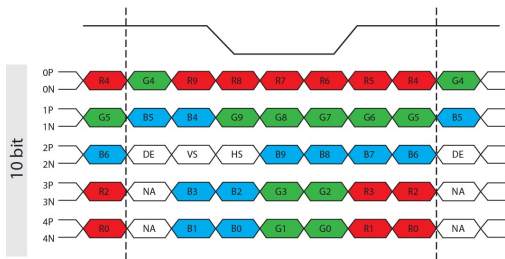

Appendix V – DV remote control unit work for HX-4096

P/N 559000106-3 :
DigitalView remote control unit
(without DV logo silk screen
printing)

P/N 559000105-3 :
DigitalView remote control unit
(with DigitalView logo silk screen
printing)



BUTTON	FUNCTION
POWER BUTTON	Soft power ON/OFF button.
SEL UP (∧) / SEL DN (∨)	1. In OSD menu, pressing "SEL UP" button to move previous level of selection. 2. In OSD menu, pressing "SEL DN" button to move next level of selection or to CONFIRM the selection.
+ BUTTON	1. When OSD menu displayed, press this button to select functions (forward) or increase the values.
- BUTTON	1. When OSD menu displayed, press this button to select functions (backward) or decrease the values.
AV/TV	1. Show input source selection menu.
OSD NEXT BUTTON	1. Use to turn on/off the OSD menu.
Mute	1. Mute / Un-mute audio (if external audio board is connected)
PIP	1. Toggle between PIP mode and 1P mode.

* Sequence of Input source selection (Press "+" Button to change source, Press "SEL DN" to confirm)

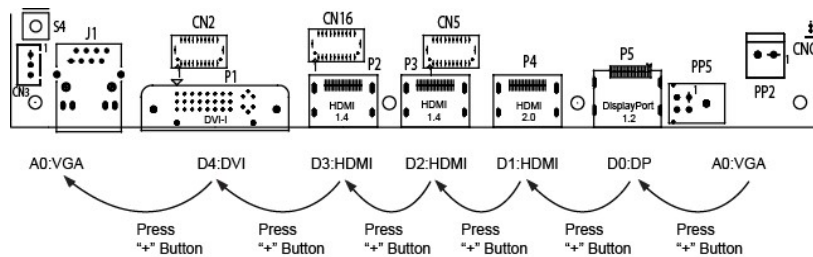

Appendix VI – PIP mix table

PIP \ MAIN	DVI (P1/CN2)	HDMI (P2/CN16)	HDMI (P3/CN5)	HDMI (P4)	DisplayPort (P5)
DVI (P1/CN2)	Yes	Yes	Yes	Yes	Yes
HDMI (P2/CN16)	Yes	Yes	Yes	Yes	Yes
HDMI (P3/CN5)	Yes	Yes	Yes	Yes	Yes
HDMI (P4)	Yes	Yes	Yes	Yes	Yes
DisplayPort (P5)	Yes	Yes	Yes	Yes	Yes

Appendix VII – Functions list on browser page

Below is a summary of functions list on IP-60's browser page.

Main

Network

Network Configure

Firmware Version	
MAC Address	
Host Name	
DHCP	On / Off
IP Address	
Subnet Mask Address	
Default Gateway Address	
Primary DNS Address	

Sensor Setting

Fan Setting

Fan 1	On / Off
Fan 2	On / Off
Fan 1 min rpm	
Fan 2 min rpm	

Light Sensor Setting

Light Sensor	On / Off
Min. Value	

Power Detect Setting

Power Source 1 (PS1)	On / Off
Power Source 2 (PS2)	On / Off
PS1 Value	
PS2 Value	

Temperature Setting

Internal Temp. Sensor	On / Off
External Temp. Sensor	On / Off
Int. Temp. Warning Value	Value
Ext. Temp. Warning Value	Value

Monitor Status

Fans Monitor (Fan 1)	
Fans Monitor (Fan 2)	
Temperture Monitor (Int. Temp.)	
Temperture Monitor (Ext. Temp.)	
Power Monitor (PS 1)	
Power Monitor (PS 2)	
Light Monitor (Light1)	

Direct Control

Picture Setting

Brightness	Value
Contrast	Value
Saturation	Value
Sharpness	Value
Hue	Value

Backlight Control

Soft Power	On / Off
Backlight Status	On / Off
Backlight Control	Value
Backlight PWM Frequency	PWM (100Hz-440Hz)

Display Mode

1P / 2P_LR / 2P_TB / 2P_PIP / 4P

Input Source Selection

P1 Input Source	Display Port/HDMI 1/HDMI 2/HDMI 3/DVI/VGA
P2 Input Source	Display Port/HDMI 1/HDMI 2/HDMI 3/DVI/VGA
P3 Input Source	Display Port/HDMI 1/HDMI 2/HDMI 3/DVI/VGA
P4 Input Source	Display Port/HDMI 1/HDMI 2/HDMI 3/DVI/VGA

Check Input Status

Check Main & PIP Source	Invalid/ARGB/HD/SD Component/DVI/HDMI/Display Port
-------------------------	--

Audio Setting

Mute	On / Off
Volume	Value
Source Selection	P1/P2/P3/P4/Analog

Color Setting

Color Temperature	3200K/5800K/6500K/7500K/9300K/sRGB/User
User - Red Level Color Temp.	Value
User - Green Level Color Temp.	Value
User - Blue Level Color Temp.	Value
Color Effect	Standard/Game/Movie/Photo/Vivid/User
Gamma	Off/1.8/2.0/2.2/2.4

Advanced Setting

Aspect Ratio	Full/16:9/4:3/5:4/1:1
Display Orientation	Normal/Anti-Clockwise 90/Rotate 180/Anti-Clockwise 270

PIP Setting

Swap	
PIP Size	(0 - 10)
PIP Horizontal Position	Value
PIP Vertical Position	Value

OSD Setting

OSD Status	On / Off
OSD Turn	On / Off
OSD Horizontal Position	Value
OSD Vertical Position	Value
OSD Menu Timeout	Value

Key Control

Menu/Down/Up/Left(-)/Right(+)

Display Information

BIOS Version
Horizontal Resolution
Vertical Resolution
Horizontal Frequency
Vertical Frequency

Load Default

Reset All Parameters	Reset all parameters to default value
Reset Parameters	Reset all parameters for all video mode to default value

WARRANTY

The products are warranted against defects in workmanship and material for a period of three (3) year from the date of purchase provided no modifications are made to it and it is operated under normal conditions and in compliance with the instruction manual.

The warranty does not apply to:

- Product that has been installed incorrectly, this specifically includes but is not limited to cases where electrical short circuit is caused.
- Product that has been altered or repaired except by the manufacturer (or with the manufacturer's consent).
- Product that has subjected to misuse, accidents, abuse, negligence or unusual stress whether physical or electrical.
- Ordinary wear and tear.

Except for the above express warranties, the manufacturer disclaims all warranties on products furnished hereunder, including all implied warranties of merchantability and fitness for a particular application or purpose. The stated express warranties are in lieu of all obligations or liabilities on the part of the manufacturer for damages, including but not limited to special, indirect consequential damages arising out of or in connection with the use of or performance of the products.

CAUTION

Whilst care has been taken to provide as much detail as possible for use of this product it cannot be relied upon as an exhaustive source of information. This product is for use by suitably qualified persons who understand the nature of the work they are doing and are able to take suitable precautions and design and produce a product that is safe and meets regulatory requirements.

LIMITATION OF LIABILITY

The manufacturer's liability for damages to customer or others resulting from the use of any product supplied hereunder shall in no event exceed the purchase price of said product.

TRADEMARKS

The following are trademarks of Digital View Ltd:

- Digital View
- HX-4096

CONTACT DETAILS

Digital View has offices in Asia, Europe and USA :

USA

Digital View Inc.
18440 Technology Drive
Building 130
Morgan Hill,
California, 95037
USA

Tel: (1) 408-782 7773 **Fax:** (1) 408-782 7883

Sales: ussales@digitalview.com

EUROPE

Digital View Ltd.
The Lake House
Knebworth Park
Herts, SG3 6PY
UK

Tel: +44-(0)20-7631-2150 **Fax:** +44-(0)20-7631-2156

Sales: uksales@digitalview.com

ASIA

Digital View Ltd
705-708, 7/F Texwood Plaza
6 How Ming St.
Kwun Tong
Hong Kong

Tel: (852) 2861 3615 **Fax:** (852) 2520 2987

Sales: hksales@digitalview.com

WEBSITE

www.digitalview.com

Revision History

Date	Rev No.	Page	Summary
19 February 2016	1.0	All	First issued.
23 March 2016	1.1	1,6,7, 23	Info updated.
10 August 2016	1.2	4,9-12, 13,15,18, 19,20-22, 27,35, 39-49	OSD, Diagram, JC1/JC2, SW4, P1- P4 pins assignment/mode, RS-232 Commands, Appendix III-V.
19 August 2016	2.0	3-4,13-17	Added jumper for 10V. Removed CN4. Added 110mA/100mA/90mA LED current.
26 January 2017	2.1	10, 15, 33-34, 47-48, 55-57, 59	LED definition, OSD menu Office address changed Added RS-232 commands Pin correction in JC1, Use of memory Functions list of browser page
20 September 2017	2.2	33, 40-42	LED definition, Use of Network connection
23 May 2023	2.3	28	Revised P5 (Display Port input) connector pin assignment.