



PC, DVI, HDMI, VIDEO, Component INTERFACE CONTROLLER FOR TFT PANEL

Model: SP-1920v2

Part number : 4178100XX-3 or up

INSTRUCTIONS

CONTENTS

Page:	2. Introduction, How to Proceed, Usage Note, Disclaimer
	3. System design – Diagram of a suggested system
	4. Assembly notes – Important information about system elements
	6. Connection & Operation – How to use the controller
	10. Connectors, pinouts & jumpers – Essential connection information
	22. Controller dimensions
	23. Application notes
	25. Troubleshooting
	26. Specifications
	28. Appendix I – Supported graphics modes table
	31. Appendix II – RS-232 control protocols
	38. Appendix III – Mapping definition
	42. Appendix IV – DV remote control unit work for SP-1920v2
	43. Appendix V – Light Sensor Function work for SP-1920v2
	44. Appendix VI - Media Failover Function
	45. Appendix VII - Port switching time
	46. Warranty, Caution & Limitation of Liability, Trademarks
	47. Contact details
	48. Revision History

It is essential that these instructions are read and understood before connecting or powering up this controller.

Introduction

Designed for LCD monitor and other flat panel display applications, the SP-1920v2 is a feature rich interface controller for :

- TFT (active matrix) LCD panels of up to 1920x1200 resolutions.
- Support true 10 bits panel.
- Computer video signals of VGA, SVGA, XGA, SXGA, WXGA, UXGA, WUXGA standard.
- Support 2 x HDMI, DVI , VGA input support up to 1920x1200 60Hz input signals
- Support Component and Composite Video signals input of NTSC, PAL and SECAM standard.

Ordering information :

Controller	Part number	Ordering part number
SP-1920v2	P/N 41780002X-3	P/N 4178000XX-3

HOW TO PROCEED

- Ensure you have all parts & that they are correct, refer to:
 - Connection diagram

Controller Solution Generator

Full web resource matching controllers & panels with **connection diagrams** for download.
See at : <http://www.digitalview.com/controllers/csg.php>

- Connector reference (in following section)
- Assembly notes (refer to page 4 – 5)
- Check controller switch & jumper settings (errors may damage the panel)
- Prepare the PC
- Connect the parts
- Understand the operation & functions

IMPORTANT USAGE NOTE

This equipment is for use by developers and integrators, the manufacturer accepts no liability for damage or injury caused by the use of this product. It is the responsibility of the developer, integrators or other user of this product to:

- Ensure that all necessary and appropriate safety measures are taken.
- Obtain suitable regulatory approvals as may be required.
- **Check power settings to all component parts before connection.**

DISCLAIMER

There is no implied or expressed warranty regarding this material.

SYSTEM DESIGN

A typical LCD based display system utilizing this controller is likely to comprise the following:

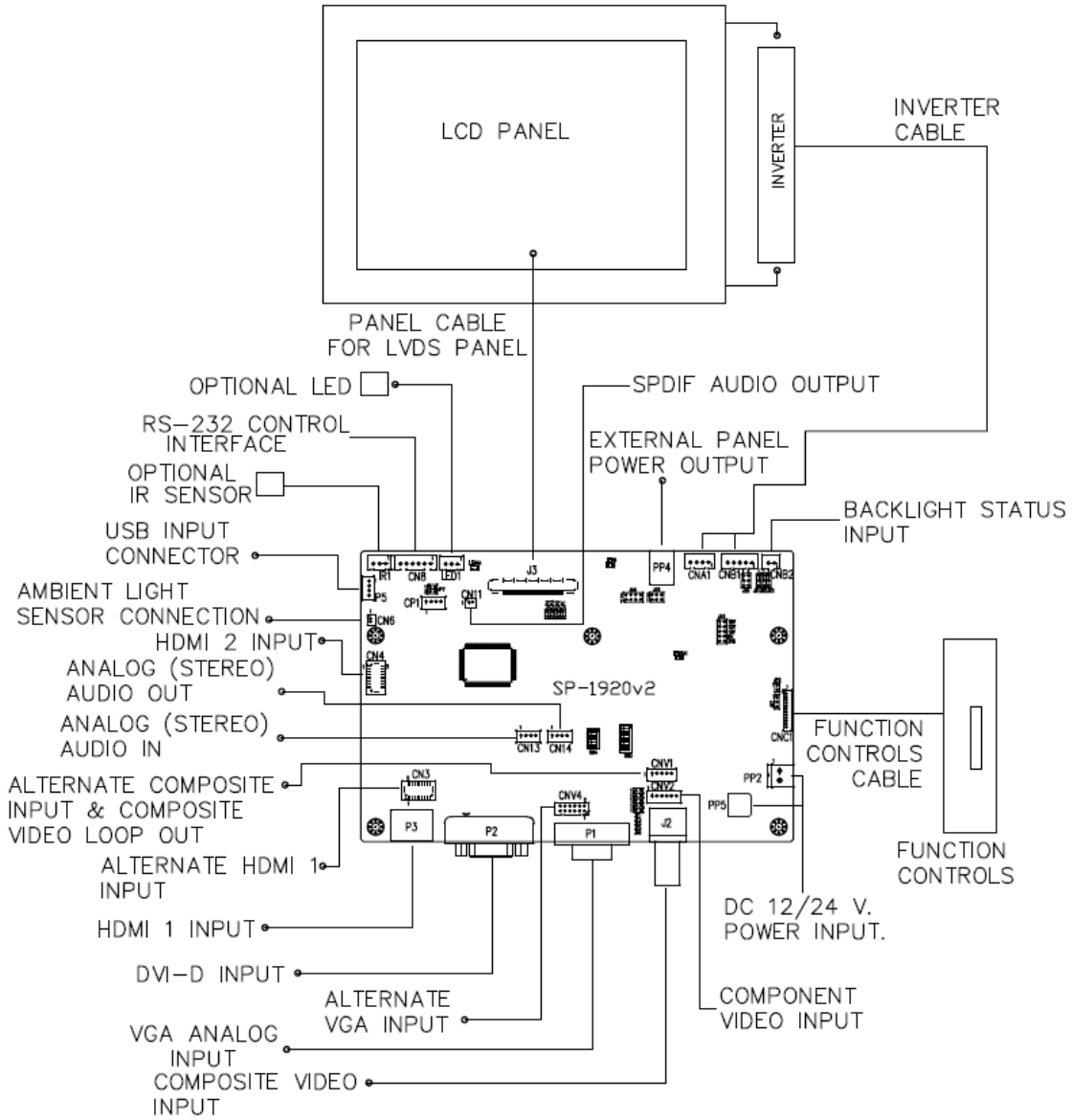

ASSEMBLY NOTES

This controller is designed for monitor and custom display projects using 1920x1200 or 1920x1080 or 1600x1200 or 1600x900 or 1680x1050 or 1440x900 or 1366x768 or 1280 x 1024 or 1280x800 or 1024 x 768 or or 1024x600 or 800x600 or 800x480 or 640x480 resolution TFT panels with a VGA, SVGA, WXGA, XGA, SXGA, UXGA or WUXGA signal input. The following provides some guidelines for installation and preparation of a finished display solution.

Preparation: Before proceeding it is important to familiarize yourself with the parts making up the system and the various connectors, mounting holes and general layout of the controller. As much as possible connectors have been labeled. Guides to connectors and mounting holes are shown in the following relevant sections.

1. **LCD Panel:** This controller is designed for typical LVDS interfaced panels with panel voltage 3.3V, 5V or 12V, External for 10V /12 / 18V interface. Due to the variation between manufacturers of panels signal timing and other panel characteristics, factory setup and confirmation should be obtained before connecting to a panel. **(NOTE: Check panel power jumper settings before connection)**
2. **Controller:** Handle the controller with care as static charge may damage electronic components. Make sure correct jumper and dip switches settings to match the target LCD panel.
3. **LCD signal cable (LVDS panel):** In order to provide a clean signal it is recommended that LVDS signal cables are no longer than 46cm (18 inches). If those wire cabling is utilized these can be made into a harness with cable ties. Care should be taken when placing the cables to avoid signal interference. Additionally it may be necessary in some systems to add ferrite cores to the cable to minimize signal noise.
5. **Inverter:** This will be required for the backlight of an LCD, some LCD panels have an inverter built in. As LCD panels may have 1 or more backlight tubes and the power requirements for different panel backlights may vary it is important to match the inverter in order to obtain optimum performance. See Application notes page 23 for more information on connection.
6. **Inverter Cables:** Different inverter models require different cables and different pin assignment. Make sure correct cable pin out to match inverter. Using wrong cable pin out may damage the inverter.
7. **Function Controls:** The following section discusses the controls required and the section on connectors provides the detail. The controls are minimal: On/Off, Backlight Brightness (depends on inverter), OSD (5 momentary buttons) or (8 momentary buttons) digital type.
8. **Function controls cable:** The cables to the function switches should be of suitable quality and length so that impedance does not affect performance. Generally lengths up to 1 meter (3 feet) should be acceptable.
9. **Status LED:** The pin direction of the LED should be corrected for right colour indication. Red colour stands for standby. Green colours stands for signal on. The status LED is an optional part only, can be unconnected.
10. **IR sensor:** It is an optional part only, can be unconnected if not using IR remote control. See Appendix IV in details.
11. **RS-232 control interface :** Serial control via CN8 interface port.
12. **VGA Input Cable:** Plug the VGA cable to the connector P1 / CNV4 (for VGA) on the controller board. As this may affect regulatory emission test results and the quality of the signal to the controller a suitably shielded cable should be utilized.
13. **DVI-D input cable :** Plug the DVI cable to the connector P2 on the controller board.
14. **HDMI 1 input :** Support HDMI 1.4(ARC) standard. Plug the HDMI cable to the connector P3 on the controller board This port is not supported when CN3 is connected. CN3 is the alternate HDMI 1 input for internal connection.
15. **HDMI 2 input :** Support HDMI 1.4(ARC) standard. Plug the HDMI cable to the connector CN4 on the controller board.
16. **Composite video input :** BNC coaxial cables to the connector J2 can be used. Reasonable quality cable should be used to avoid image quality degradation.
17. **Alternate composite video input and composite video loop out :** Plug the video input cable P/N 426308000-3 on CNV1 connector.
18. **Component video input :** Plug the component video input cable P/N 426000600-3 on CNV2 connector

19. Power Input: 12V/24VDC is required, this should be a regulated supply. The power rating is depending on the panel and inverter used. Normally, power supply with 3.5Amp current output should enough for most of 4x CCFT panels. Although the controller provides power regulation for the LCD power this does not relate to the power supplied to the backlight inverter. If an unregulated power supply is provided to an inverter any fluctuations in power may affect operation, performance and lifetime of the inverter and or backlight tubes.

20. External panel power input : Allow to supply external power to the panel separately for max 3.3V (7A) or 5V (7A) or 10V (6A) or 12V (5A) or 18V (3.5A) via PP4 power input connector.

21. SPDIF Audio output : This port (CN11) support SPDIF audio output from the HDMI audio source inputted.

22. Ambient light sensor connection : 2 ways connector provides interface for connection using light sensor cable (with sensor) P/N 426321940-3 (1000mm) or Light sensor board P/N 416021310-3/416021330-3 with light sensor cable P/N 426305900-3 (1250mm) via CN6 connector.

23. Backlight status input : 2 ways connector (CNB2) provides interface for connection with panel which support the panel with backlight status monitoring function.

24. USB input connector : For media file playback (h.264) for failover function or firmware upgrade purpose via P5 connector.

- **Power output:** Note the controller has an overall 3Amp current limit and the current available from the auxiliary power output will be dependent on the power input and other system requirements.
- **Power Safety:** Note that although only 12V / 24VDC is required as 'power-in' a backlight inverter for panel backlighting produces significantly higher voltages (the inverter does not connect to the ground plane). We strongly advise appropriate insulation for all circuitry.
- **EMI:** Shielding will be required for passing certain regulatory emissions tests. Also the choice of external Controller to PC signal cable can affect the result.
- **Ground:** The various PCB mounting holes are connected to the ground plane.
- **Servicing:** The board is not user serviceable or repairable. Warranty does not cover user error in connecting up to the controller and is invalidated by unauthorized modification or repairs.
- **Controller Mounting:** It is recommended that a clearance of at least 10mm is provided above and 5mm below the controller when mounted. Additionally consideration should be given to:
 - Electrical insulation.
 - Grounding.
 - EMI shielding.
 - Cable management. Note: It is important to keep panel signal cables apart from the inverter & backlight cables to prevent signal interference.
 - Heat & Ventilation: Heat generated from other sources, for example the backlight of a very high brightness panel may generate significant heat which could adversely affect the controller.
 - Other issues that may affect safety or performance.
- **PC Graphics Output:** A few guidelines:
 - Signal quality is very important, if there is noise or instability in the PC graphics output this may result in visible noise on the display.
 - Refer to graphics modes table in specifications section for supported modes.
 - Non-interlaced & interlaced video input is acceptable.

IMPORTANT: Please read the Application Notes section for more information.

CONNECTION & OPERATION

CAUTION: Never connect or disconnect parts of the display system when the system is powered up as this may cause serious damage.

CONNECTION

Connection and usage is quite straight forward (it is useful to have the relevant connection diagram available at this time):

1. **LCD panel & Inverter:** Connect the inverter (if it is not built-in the panel) to the CCFT lead connector of the LCD panel.
LVDS type panels: The controller board has the built-in LVDS transmitter driver. Plug the LVDS cable to J3. Insert the panel end of the cable the LCD panel connector.
2. **Inverter & Controller:** Plug the inverter cable to CNB1 and CNA1 (if necessary). Plug another end to the connector on the inverter.
3. **Function switch & Controller:** Plug the OSD switch mount cable to CNC1 on the controller board and another to the OSD switch mount.
4. **LED & Controller:** Plug in a 3-way with dual colour LED to connector LED1 on the controller board.
4. **IR & Controller:** Plug in a 3-way with IR sensor to connector IR1 on the controller board.
6. **Jumpers & Switches:** Check all jumpers and switches (SW3, SW4) are set correctly. Details referring the connection diagram (a separate document) or the jumpers and switches setting table (in the following section).
7. **Jumpers & Inverter & Panel voltage:** Particularly pay attention to the settings of JA3, JA5, JA6, JB2 and JB3. JB2 & JB3 are used for inverter control (read inverter specification and information on the jumper table to define the correct settings). JA3 & JA5 & JA6 is used for panel voltage input (read panel specification and information on the jumper table to define the correct settings).
8. **Input signal cable & Controller:** Plug the corresponding signal input to the connector on the controller board.
9. **Power supply & Controller:** Plug the DC 12V/24V power in to the connector PP5 or PP2. You can consider to use DigitalView mating power cable P/N 426013800-3, 160mm for PP5 connection.
11. **External panel power input :** Plug power cable : P/N 426013700-3 for external panel power input (3.3 (max 7A) / 5V (max 7A) / 12V (max 5A) / 18V (max3.5))
12. **Power on:** Switch on the controller board and panel by using the OSD switch mount.

LED status (LED1 / LED1A) :

Backlight status	LED color
Backlight OFF	RED
Backlight ON	GREEN

LED status (LED5A1) :

	LED color
Controller power ON	Green

LED status (LED6) :

Panel power output status	LED color
10V / 12V / 18V panel power output	GREEN
3.3V / 5V panel power output	RED

General:

- If you are using supplied cables & accessories, ensure they are correct for the model of panel and controller.
- If you are making your own cables & connectors refer carefully to both the panel & inverter specifications and the section in this manual, "Connectors, Pinouts & Jumpers" to ensure the correct pin to pin wiring.

PC SETTINGS

The controller has been designed to take a very wide range of input signals however to optimize the PC's graphics performance we recommend choosing 60Hz vertical refresh rate – this will not cause screen flicker.

OPERATION

Once the system has been connected and switched on there are a number of functions available to adjust the display image as summarized in the following sections. The settings chosen will be saved for each mode independently.

LCD DISPLAY SYSTEM SETTINGS

NOTE: By way of explanation the following refers to a set of sample buttons that may be obtained as an option. In addition to power on/off and connection for backlight brightness the controller provides an On Screen Display of certain functions which are controlled by 5 momentary type buttons (analog VR type) or 8 momentary type buttons (digital type):

Controls	Digital type	5 button OSD switch mount board
On/Off – turns controller board power on	On/Off button	NIL
Brightness – controls backlight brightness	Brightness +/- buttons	NIL
Menu – Turns OSD menu On or Off (it will auto time off) – Back to top of OSD sub-menu page	Menu button	Menu button
Select down – Moves the selector to the next function (down)	SEL DN	SEL DN
Select up – Moves the selector to the previous function (up)	SEL UP	SEL UP
+ – Increase the OSD parameter values – Go into the sub-menu page – Confirm to select the OSD function	+	+
- – Decrease the OSD parameter values	-	-
Reset to Factory Defaults	Press and hold SEL DN button, then power on the controller	Press and hold SEL DN button, then power on the controller
Soft power off and on	Hold Menu button for 3-4 seconds Press Menu button to turn back on	Hold Menu button for 3-4 seconds Press Menu button to turn back on

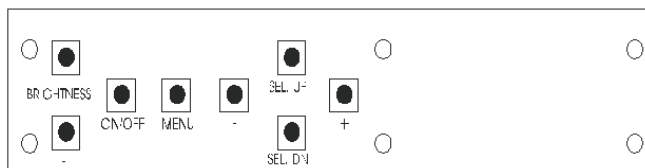

Digital type

Digital 10K Type OSD switch mount
P/N 416100520-3 or up,
matching cable
P/N 426122200-3.

5 keys OSD switch mount board

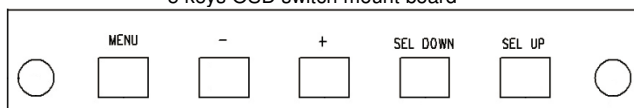

5 buttons OSD switch mount board P/N 4161003700-3,
matching cable
P/N 426123010-3.



Picture :

Picture Mode ▶

Contrast [0~100] Default 50 : Increase/decrease panel contrast level, total: 100 steps
Black Level [0~100] Default 50 : Increase/decrease panel brightness level, total: 100 steps
Saturation** [0~100] Default 50 : Increase/decrease panel saturation level, total: 100 steps
Sharpness** [0~100] Default 50 : Increase/decrease sharpness, total: 100 steps
Hue* [0~100] Default 50 : Increase/decrease Hue level, total: 100 steps

Color Temperature ▶

5000K
6500K
7500K (Default)
9300K

User ▶

Red [0~255] : Red Gain
Green [0~255] : Green Gain
Blue [0~255] : Blue Gain

Aspect Ratio ▶

Fill Screen : Default Enable full screen expansion for lower resolution Image
4:3 : scaling format in 4:3
16:9 : scaling format in 16:9
1:1 : Display the exact image resolution on the screen without image expansion.

Advance# ▶

Auto Picture Setup : Auto adjust the image position, phase and size
Auto Color Gain : Auto Color Calibration
H-Pos [0~100] : Move the image position horizontally
V-Pos [0~100] : Move the image position vertically
Clock [0~100] : Adjust the image horizontal size
Phase [0~100] : Fine tune the data sampling position (adjust image quality)

Aspect Ratio ▶

4:3 : scaling format in 4:3
Fill Screen : Default Enable full screen expansion for lower resolution Image
16:9 : scaling format in 16:9
Point to Point : Display the exact image resolution on the screen without image expansion.

Brightness [0~100] : Default 100 : Backlight brightness adjustment

Input Source ▶ Select the input video signal

Component
VGA
DVI
HDMI1
HDMI2
Composite

* Function in Composite mode only

** Function in Composite & HDMI modes only

Function in VGA mode only



Utilities :

Menu language : English / French / Spanish

Setup ▶

Auto power : OFF / ON

ON – Enable soft power off function if absence of input signals
OFF – Disable soft power function

Auto Source Seek : On/Off (Default On) : Select Auto source select enable or disable.

Image Orientation ▶ Set the image orientation (with OSD menu) on screen

Normal
H-Flip
V-Flip
HV-Flip

Gamma : 1.8 / 2.0 / 2.2 / 2.4 / 2.6 (Default 2.2)

FailOver On/Off (Default OFF) - See Appendix V in details.

Default power : ON/OFF (Default power ON)

Off : When the controller detects power in, it will stay in 'Stand-by' mode.
On : When the controller detects power in, it will turn on the power and display

OSD ▶

OSD Time Out : ON / 5 Sec / 15 Sec / 30 Sec (Default) / 45 Sec / 60 Sec : Adjust the OSD menu timeout period

Transparent : 0% / 25% (Default) / 50% / 75% / 100% : Set OSD transparency

Reset to Factory Defaults ▶ Restore back to factory default values.
Are you sure ? Yes / No

Software Update (USB) : Firmware upgrade

Hotkey ▶

Hotkey 1 : Volume / Black Level / Contrast / Input Source / Aspect/Size / Saturation / Image Orientation / Brightness / Auto Picture Setup / Off

Hotkey 2 : Volume / Black Level / Contrast / Input Source / Aspect/Size / Saturation / Image Orientation / Brightness / Auto Picture Setup / Off

Brightness Setup :

Invert : OFF / ON : Invert for the backlight brightness

Control : D/A / PWM : Selection for voltage level dimming control / PWM dimming control

Frequency(Hz) : 100 ~ 440Hz in a step of 20

Min Level : 0 ~ 50% : Default the minimum backlight adjustment.

Light Detector : ON / OFF

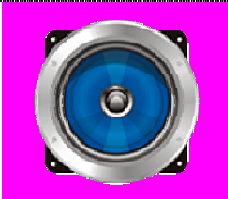

Audio :

Volume [0~100] : Default 50 : Increase/decrease volume level, total: 100 steps

Effective on Firmware V1.10.00.00 or up

CONNECTORS, PINOUTS & JUMPERS

The various connectors are:

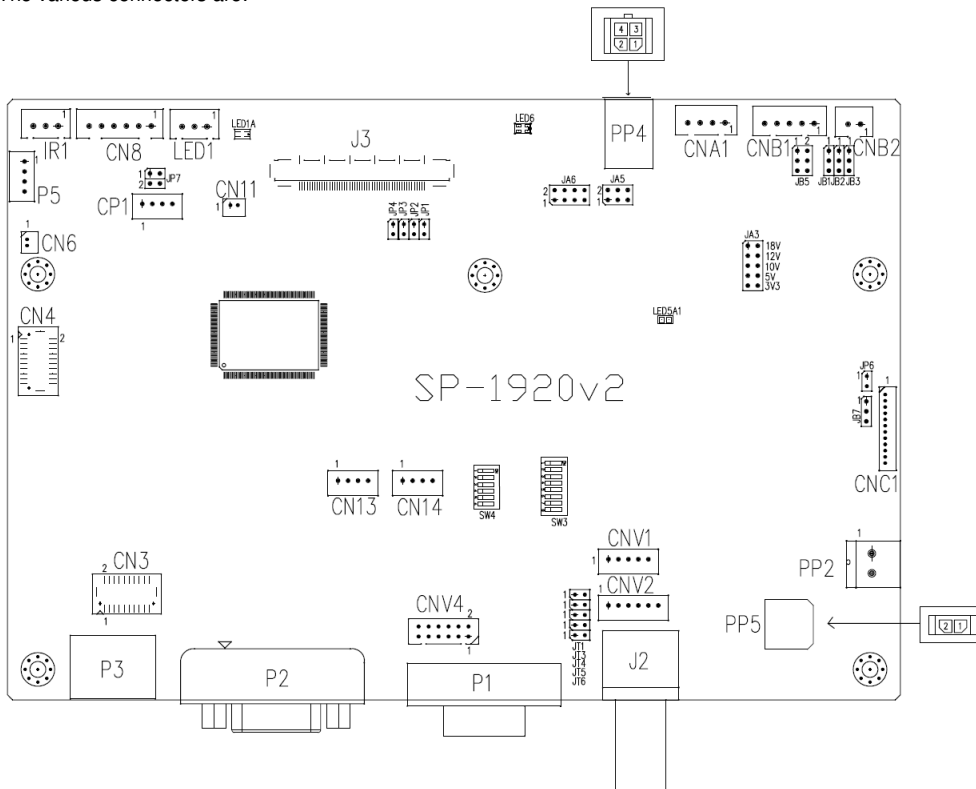

Summary: Connectors

Ref	Purpose	Description
CN3	Alternate HDMI 1 connector	JST BM20B-SRDS compatible (Matching type : SHDR-20V-S-B) (Matching extend cable with female HDMI connector : P/N 426301800-3) (Matching extend cable with male HDMI connector : P/N 426006600-3)
CN4	HDMI 2 input connector	JST BM20B-SRDS compatible (Matching type : SHDR-20V-S-B) (Matching extend cable with female HDMI connector : P/N 426301800-3) (Matching extend cable with male HDMI connector : P/N 426006600-3)
CN6	Ambient light sensor connector	Hirose DF13-2P-1.25DSA (Mating type : DF13-2S-1.25C)
CN8	RS-232 serial control	JST 6-way, B6B-XH-A compatible (Matching type : XHP-6)
CN11	SPDIF Audio output	JST B2B-ZR compatible (Matching type : ZHR-2) (Matching extend cable P/N 426007400-3)
CN13	Analog audio (Stereo) in	JST 4 way, B4B-PH-K compatible (Matching type : PHR-4)
CN14	Analog audio (Stereo) out	JST 4 way, B4B-PH-K compatible (Matching type : PHR-4)
CNA1	Auxiliary power output	JST 4-way, B4B-XH-A compatible (Matching type : XHP-4) (Matching cable P/N 426040200-3)
CNB1	Backlight inverter	JST 5-way, B5B-XH-A compatible (Matching type : XHP-5)
CNB2	Backlight status input connector	JST 2 way, B2B-XH-A compatible (Matching type : XHP-2)
CNC1	OSD controls	Hirose DF13-12P-1.25H compatible (Mating type : DF13-12S-1.25C) (Matching OSD switch mount cable P/N 426122200-3 (150mm) or 426122210-3 (250mm))
CNV1	Alternate video in (Composite & Composite loop out)	JST 5-way, B5B-PH-K compatible (Matching type : PHR-5) (Matching video cable P/N 426308000-3)
CNV2	Component video input connector:	JST 6-way, B6B-PH-K compatible (Matching type : XHP-6) (Matching video cable P/N 426000600-3)
CNV4	Alternate VGA input connector	Hirose 12-pin, DF11-12DP-2DSA compatible (Matching type : DF11-12DS-2C)
IR1	Infra-Red sensor connector	JST 3-way, B3B-XH-A compatible (Matching type : XHP-3)
J2	Composite video in	BNC connector
J3	Panel signal for LVDS panel	JAE FI-RE51S-HF compatible (Matching type : FI-RE51HL)
LED1	Dual color LED connector	JST B3B-XH-A compatible (Matching type : XHP-3)

Specifications subject to change without notice

P1	VGA analog input	DB-15 way high density 3 row
P2	DVI-D	DVI-D connector
P3	HDMI 1 input connector	HDMI connector
P5	USB connector	JST B4B-PH-K compatible (Matching type : PHR-4)
PP2	Power input (alternative)	DC power Molex 2 pin 0.156" pitch
PP4	External panel power input	Molex 43045-0400 compatible (Matching connector type : Molex 43025-0400 compatible) (Matching power cable : P/N 426013700-3)
PP5	Power input	Molex 43650-0200 compatible (Matching connector type : Molex 43645-0200 compatible) (Matching power cable : P/N 426013800-3)

Summary: Jumpers setting

Ref	Purpose	Note
JA3	Panel power voltage select CAUTION: Incorrect setting can damage panel	See panel voltage setting table 1
JA5	Panel power voltage select CAUTION: Incorrect setting will cause panel damage	See panel voltage setting table 1
JA6	Panel power voltage select CAUTION: Incorrect setting will cause panel damage	See panel voltage setting table 1
JB1	Backlight brightness voltage range	1-2 closed = 5V max 2-3 closed = 3.3V max
JB2	Backlight inverter on/off control – signal level	2-3 = On/Off control signal 'High' = +5V 1-2 = On/Off control signal 'High' = +3.3V Open = On/Off control signal 'High' = Open collector CAUTION: Incorrect setting can damage inverter.
JB3	Backlight inverter on/off control – polarity	1-2 = control signal 'high' = CCFT ON 2-3 = control signal 'low' = CCFT ON
JB5	Backlight control type selection	1-2 = VR/Digital switch mount control 3-4 = Analog backlight brightness - voltage range 0~5V 5-6 = PWM (Pulse Width Modulation) brightness
JB7	Backlight control voltage on CNB1 pin 4 (Function when JB5 sets 1-2 closed)	Open = For OSD switch mount control (Default) 1-2 = 0V 2-3 = 3.3V / 5V controlled by JB1
JP1	GPIO pins enable	Open : Enable J3 – pin 16 (OP1) to 3.3V Closed : Enable J3 – pin 16 (OP1) to Ground
JP2	GPIO pins enable	Open : Enable J3 – pin 17 (OP2) to 3.3V Closed : Enable J3 – pin 17 (OP2) to Ground
JP3	GPIO pins enable	Open : Enable J3 – pin 18 (OP3) to 3.3V Closed : Enable J3 – pin 18 (OP3) to Ground
JP4	GPIO pins enable	Open : Enable J3 – pin 19 (OP4) to 3.3V Closed : Enable J3 – pin 19 (OP4) to Ground
JP6	Input power control	Short = External switch control Open = Switch mount control
JP7	Internal programming use	Default 1-3 & 2-4 closed
JT1	Reserved	Default Open
JT3	Composite video-in terminator enable	Open = composite video input is not terminated Close = composite video input is terminated with 75Ω
JT4	Component luma-in terminator enable	Open = Component luma input is not terminated Close = Component luma input is terminated with 75Ω
JT5	Component Cb/Pb-in terminator enable	Open = Component Cb/Pb input is not terminated Close = Component Cb/Pb input is terminated with 75Ω
JT6	Component Cr/Pr-in terminator enable	Open = Component Cr/Pr input is not terminated Close = composite Cr/Pr input is terminated with 75Ω
SW3	Panel & function selection	See table 2
SW4	Panel & function selection	See table 3

Table 1 : Panel voltage setting table :

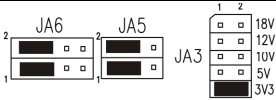
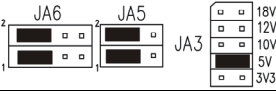
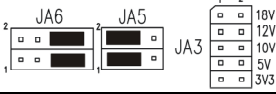



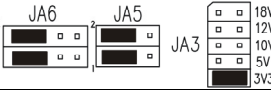
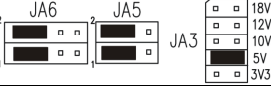
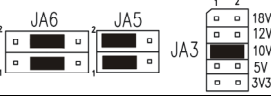
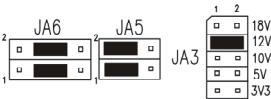
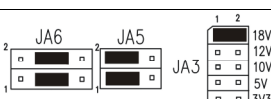









Input voltage via PP2, PP5	Panel Voltage	JA3	JA5	JA6	Jumper on board
12VDC	3.3V	3V3 closed	1-3 & 2-4	1-3 & 2-4	
	5V	5V closed	1-3 & 2-4	1-3 & 2-4	
	12V	OPEN	1-3 & 2-4	5-7 & 6-8	

CAUTION: Incorrect setting can damage panel & controller

Input voltage via PP2, PP5	Panel Voltage	JA3	JA5	JA6	Jumper on board
24VDC**	3.3V	3V3 closed	1-3 & 2-4	1-3 & 2-4	
	5V	5V closed	1-3 & 2-4	1-3 & 2-4	
	10V	10V closed	1-3 & 2-4	3-5 & 4-6	
	12V	12V closed	1-3 & 2-4	3-5 & 4-6	
	18V	18V closed	1-3 & 2-4	3-5 & 4-6	

CAUTION: Incorrect setting can damage panel & controller

**** Ensure that the backlight inverter supports 24V operation prior to connecting a 24VDC input. Because CNA1 pin 1 and CNB1 pin 2 will output 24VDC if input 24VDC via PP2/PP3 or PP5.**

Input voltage via PP4	Input voltage via PP2 / PP5	Panel Voltage	JA3	JA5	JA6	Jumper on board
3.3 / 5 / 10 / 12 / 18VDC*	12V / 24VDC	3.3V	OPEN	3-5 & 4-6	1-3 & 2-4	  
		5V	OPEN	3-5 & 4-6	1-3 & 2-4	  
		10V	OPEN	3-5 & 4-6	3-5 & 4-6	  
		12V	OPEN	3-5 & 4-6	3-5 & 4-6	  
		18V	OPEN	3-5 & 4-6	3-5 & 4-6	  

* Maximum current for 3.3V, 5V = 7A, Maximum current for 12V = 5A, Maximum current for 18V = 3.5A

JA3, JA5 & JA6 location on board : (Please pay attention to the jumper settings on JA3, JA5 & JA6 which are red in color)

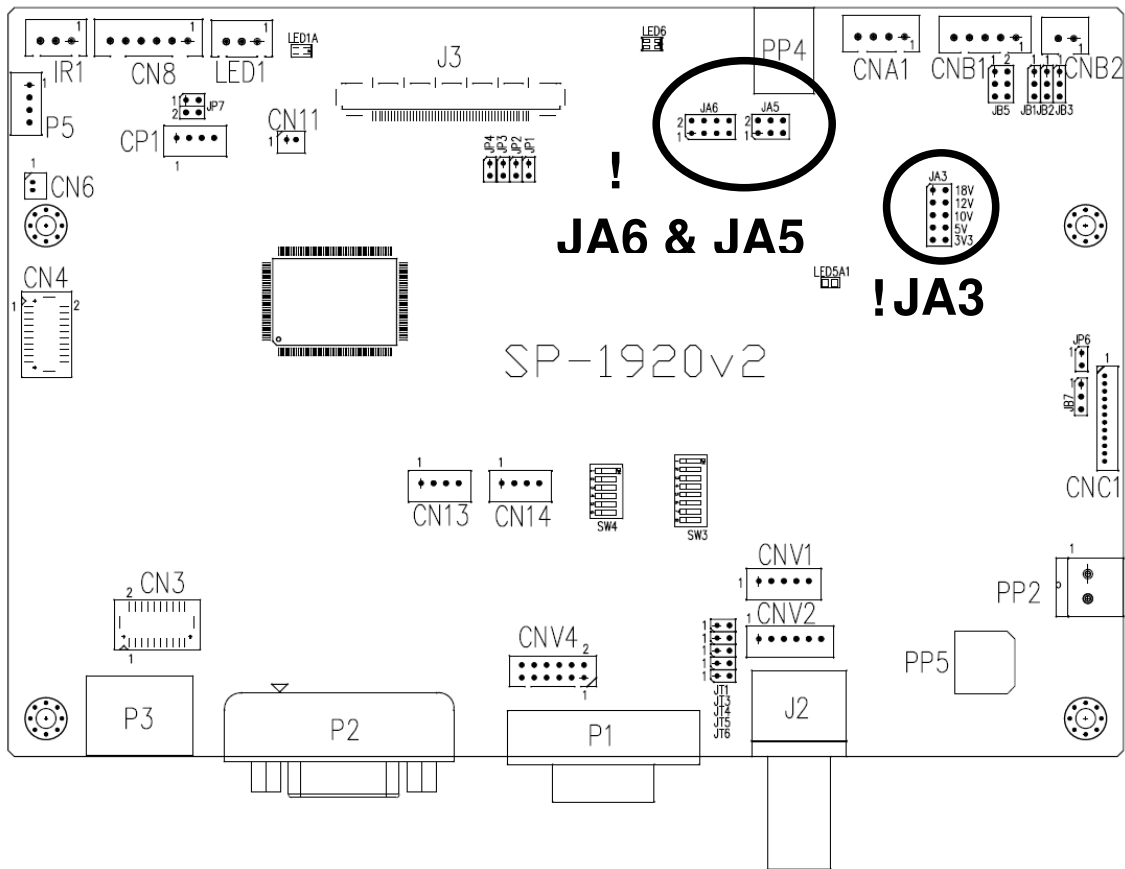

Table 2 : DIP Switch selection – SW3

Pos #1	Pos #2	Pos #3	Pos.#4	Description	Panel resolution
For WUXGA panels					
OFF	ON	ON	OFF	LG LM260WU1-SLB1	1920x1200
ON	ON	ON	OFF	LG LM240WU2-SLA1	1920x1200
OFF	OFF	OFF	OFF	Sharp LQ445D3LZ19	1920x1080
ON	OFF	OFF	OFF	Samsung LTA460H2-L02	1920x1080
OFF	ON	OFF	OFF	Sharp LQ170M1LZ04	1920x1200
ON	ON	OFF	OFF	Samsung LTA700HH-LH1 (1 st trial testing)	1920x1080
OFF	OFF	ON	OFF	Samsung LTA700HH-LH1 (2 nd trial testing)	1920x1080
OFF	OFF	ON	ON	AU Optronics P645HW03 V0 (1920x1080)	1920x1080
OFF	OFF	ON	ON	AU Optronics P645HW03 V0	1920x1080
For UXGA panels					
OFF	OFF	OFF	OFF	Fujitsu FLC59UXC8V-02A	1600x1200
ON	OFF	OFF	OFF	Samsung LTM213U6-L01	1600x1200
For WXGA panels					
OFF	OFF	OFF	OFF	LG LC420W02-A4	1366x768
ON	OFF	OFF	OFF	Sharp LQ315T3LZ24	1366x768
ON	ON	OFF	OFF	Samsung LTA320W2-L01 / LTA230W1-L02	1366x768
ON	ON	ON	ON	NEC NL12876BC26-21 / Samsung LTM170W1-L01	1280x768
OFF	ON	ON	ON	CHI MEI N154I4-L01	1280x800
OFF	OFF	ON	OFF	AU Optronics M190PW01	1440x900
OFF	OFF	ON	ON	Sharp LQ072K1LA03	1280x768
For SXGA panel					
OFF	OFF	OFF	OFF	Sharp LQ181E1LW31	1280x1024
ON	OFF	OFF	OFF	AU Optronics M170EN05	1280x1024
For XGA panel					
OFF	OFF	OFF	OFF	Sharp LQ150X1LGN2A Sharp LQ150X1LGB1	1024x768 1024x768
For SVGA panel					
OFF	OFF	OFF	OFF	Sharp LQ121S1DG11/41	800x600
				Toshiba LTM08C351	800x600
For WVGA panel					
OFF	OFF	OFF	OFF	NEC NL8048BC24-01	800x480
ON	OFF	OFF	OFF	Kyocera TCG085WV1AB-G00	800x480
ON	OFF	ON	OFF	Sharp LQ070Y3LG4A	800x480
For VGA panel					
OFF	OFF	OFF	OFF	Sharp LQ104V1DG51	640x480
ON	OFF	OFF	OFF	Sharp LQ104V1DG21	640x480
ON	OFF	ON	OFF	Kyocera TCG075VG2AC-G00	640x480
Others					
OFF	ON	OFF	OFF	AU Optronics M201EW02 V8	1680x1050
ON	OFF	OFF	ON	Samsung LTM201M1-L01	1680x1050

Remark : The above panel timings are generated based on the panel specification. Some of the panel timings settings may not exactly to match the panel model we specified in this table.

Pos #5	Pos #6	Pos #7	Description
OFF	OFF	OFF	WUXGA
ON	OFF	OFF	UXGA
OFF	ON	OFF	SXGA
ON	ON	OFF	WXGA
OFF	OFF	ON	XGA
ON	OFF	ON	SVGA
OFF	ON	ON	VGA
ON	ON	ON	WVGA / Others

Pos. #8	Reserved

Table 3 : DIP switch selection – SW4

Pos. #	Function	Description
1	Reserved	Reserved
2	Panel pixel format	OFF : Double Pixel ON : Single Pixel
3	Panel selection	Default ON : Single / Double pixel LVDS panel (controlled by SW4 position 2)
4	LVDS data mapping select (Refer to Table 2)	If SW4 position 5 = OFF (8 bit) OFF : Mapping B ON : Mapping A Please adjust to get the correct picture. See as Appendix I for details of mapping of A and B. If SW4 position 5 = ON (10 bit) OFF : JEIDA (LVDS panel) ON : VESA (LVDS panel) Please adjust to get the correct picture. See as Appendix I for details of mapping of VESA and JEIDA.
5	Output LVDS display mode selection	OFF : 8 bit ON : 10 bit
6	Reserved	Reserved

Support "Resolution default by EDID" for different resolution panel.

The controller will set the preferred timing based off the dip switch setting (SW3 position 1-7) selection, but also be able to go higher to 1920x1200. For example, if the panel is a 1024x768 and the dip switch setting are set for 1024x768. The preferred EDID resolution should be 1024x768. It should also have the capability to set the max resolution to 1920x1200.

CN3 - Alternate HDMI 1 connector : JST BM20B-SRDS compatible (Matching type : SHDR-20V-S-B)

PIN	SYMBOL	DESCRIPTION
1	GND	Ground
2	GND	Ground
3	RXC+	TMDS Data C+
4	RXC-	TMDS Data C-
5	RX0+	TMDS Data 0+
6	RX0-	TMDS Data 0-
7	RX1+	TMDS Data 1+
8	RX1-	TMDS Data 1-
9	RX2+	TMDS Data 2+
10	RX2-	TMDS Data 2-
11	GND	Ground
12	GND	Ground
13	MSTR2_SCL	Reserved
14	MSTR2_SDA	Reserved
15	DDC_5V	+5V power supply for DDC (optional)
16	HPD	Hot plug detection
17	DDC_SCL	DDC serial clock
18	DDC_SDA	DDC Data
19	CEC	Consumer Electronics Control(CEC) pin
20	VCC2	VCC 5V output

CN4 - HDMI 2 connector : JST BM20B-SRDS compatible (Matching type : SHDR-20V-S-B)

PIN	SYMBOL	DESCRIPTION
1	GND	Ground
2	GND	Ground
3	RXC+	TMDS Data C+
4	RXC-	TMDS Data C-
5	RX0+	TMDS Data 0+
6	RX0-	TMDS Data 0-
7	RX1+	TMDS Data 1+
8	RX1-	TMDS Data 1-
9	RX2+	TMDS Data 2+
10	RX2-	TMDS Data 2-
11	GND	Ground
12	GND	Ground
13	MSTR2_SCL	Reserved
14	MSTR2_SDA	Reserved
15	DDC_5V	+5V power supply for DDC (optional)
16	HPD	Hot plug detection
17	DDC_SCL	DDC serial clock
18	DDC_SDA	DDC Data
19	CEC	Consumer Electronics Control(CEC) pin
20	VCC2	VCC 5V output

CN6 – Ambient light sensor connector : Hirose DF13-2P-1.25DSA compatible (Mating type : DF13-2S-1.25C)

PIN	SYMBOL	DESCRIPTION
1	3.3V	3.3V
2	ALS	Ambient light sensing

CN8 – RS-232 serial control: JST B6B-XH-A compatible (Matching type : XHP-6)

PIN	SYMBOL	DESCRIPTION
1	SCLK	Reserved
2	SDATA	Reserved
3	VCC	+5V
4	TXD	RS-232 Tx data
5	GND	Ground
6	RXD	RS-232 Rx data

CN11 – SPDIF audio output connector : JST B3B-PH-K compatible (Matching type : PHR-3)

PIN	SYMBOL	DESCRIPTION
1	SPDIF	SPDIF Digital audio output
2	GND	Ground

CN13 – Analog (Stereo) audio in connector: JST B4B-PH-K compatible (Matching type : PHR-4)

PIN	SYMBOL	DESCRIPTION
1	GND	GND
2	AUDIO LIN	HDMI LEFT IN
3	GND	GND
4	AUDIO RIN	HDMI RIGHT IN

CN14 –Analog (Stereo) audio out connector: JST B4B-PH-K compatible (Matching type : PHR-4)

PIN	SYMBOL	DESCRIPTION
1	GND	GND
2	AUDIO LOUT	HDMI LEFT OUT
3	GND	GND
4	AUDIO ROUT	HDMI RIGHT OUT

CNA1 - Auxiliary power output: JST B4B-XH-A (Matching type : XHP-4)

PIN	SYMBOL	DESCRIPTION
1	AUX 12V / 24V	+12V / +24V DC
2	GND	Ground
3	GND	Ground
4	AUX 5V	+5V DC, 500mA max

CNB1 – Backlight inverter connector: JST B5B-XH-A compatible (Matching type : XHP-5)

PIN	SYMBOL	DESCRIPTION
1	GND	Ground
2	VBKL	+12V / +24V DC, backlight power supply
3	BLCTRL	On/Off control (enable) – see JB2 & JB3
4	BVR_WIP	Brightness VR – WIP
5	BVR_A	Brightness VR A

CNB2 – Backlight status input inverter connector: JST B2B-XH-A compatible (Matching type : XHP-2)

PIN	SYMBOL	DESCRIPTION
1	BL_STATUS	Backlight status (Normal = High)
2	GND	Ground

CNC1 – OSD switch mount control, Hirose DF13-12P-1.25H compatible (Mating type : DF13-12S-1.25C)

PIN	SYMBOL	DESCRIPTION
1	PSWIN	Power Button A = ON/OFF Button in
2	SW_ON	Power Button B = ON/OFF Button out
3	BVR_A	Backlight Brightness VR pin A
4	BVR_WIP	Backlight Brightness R pin WIP
5	BVR_B	Backlight Brightness VR pin B (470 ohm resistor to +5V Vcc)
6	GND	Ground
7	MENU	OSD menu
8	-/LEFT	OSD -/Left
9	+/RIGHT	OSD +/Right
10	SEL_DN	OSD Select down
11	SEL_UP	OSD Select up
12	NC	No connection

The VR for brightness depends on the inverter. The main power load for On/Off is handled by a relay on the controller.

CNV1 – Alternate Video in input, JST B5B-PH-K compatible (Matching type : PHR-5)

PIN	DESCRIPTION
1	Composite video loop out
2	Reserved
3	Ground
4	Ground
5	Composite video in

CNV2 – Component (YPbPr) video input connector: JST 6-way, B6B-PH-K compatible (Matching type : XHP-6)

PIN	SYMBOL	DESCRIPTION
1	A_Y1	Luma in / Green in
2	GND	Ground
3	A_Pb1	Pb in / Blue in
4	GND	Ground
5	A_Pr1	Pr in / Red in
6	GND	Ground

CNV4 - Alternate VGA input : HIROSE DF11-12DP-2DSA compatible

PIN	SYMBOL	DESCRIPTION
1	R	Red, analog
2	DDC_5V	+5V power supply for DDC (optional)
3	G	Green, analog
4	GND	Ground
5	B	Blue, analog
6	GND	Ground
7	HS	Horizontal sync or composite sync, input
8	GND	Ground
9	VS	Vertical sync, input
10	DDC_SCL	DDC serial clock
11	NC	No connection
12	DDC_SDA	DDC serial data

IR1 – Infra-Red sensor connector: JST B3B-XH-A compatible (Matching type : XHP-3)

PIN	SYMBOL	DESCRIPTION
1	GND	Ground
2	STDBY_Vcc	Stand by voltage
3	IR Data	IR data

J3 – LVDS output connector: JAE FI-RE51S-HF compatible (Matching type : JAE FI-RE51HL)

PIN	SYMBOL	DESCRIPTION
1	VLCD_HV	Panel power supply (+10V / 12V / 18V) (selected by JA3, JA5 & JA6)
2	VLCD_HV	Panel power supply (+10V / 12V / 18V) (selected by JA3, JA5 & JA6)
3	VLCD_HV	Panel power supply (+10V / 12V / 18V) (selected by JA3, JA5 & JA6)
4	VLCD_HV	Panel power supply (+10V / 12V / 18V) (selected by JA3, JA5 & JA6)
5	VLCD_HV	Panel power supply (+10V / 12V / 18V) (selected by JA3, JA5 & JA6)
6	VLCD_LV	Panel power supply (3,3V/5V) (selected by JA3, JA5 & JA6)
7	VLCD_LV	Panel power supply (3,3V/5V) (selected by JA3, JA5 & JA6)
8	VLCD_LV	Panel power supply (3,3V/5V) (selected by JA3, JA5 & JA6)
9	VLCD_LV	Panel power supply (3,3V/5V) (selected by JA3, JA5 & JA6)
10	VLCD_LV	Panel power supply (3,3V/5V) (selected by JA3, JA5 & JA6)
11	GND	Ground
12	GND	Ground
13	GND	Ground
14	GND	Ground
15	GND	Ground
16	OP1	-
17	OP2	-
18	OP3	-
19	OP4	-
20	GND	Ground
21	GND	Ground
22	LVDS_OUT1_A4+	Positive differential LVDS data bit A4
23	LVDS_OUT1_A4-	Negative differential LVDS data bit A4
24	LVDS_OUT1_A3+	Positive differential LVDS data bit A3
25	LVDS_OUT1_A3-	Negative differential LVDS data bit A3
26	GND	Ground
27	LVDS_OUT1_AC+	Positive LVDS clock for A channel
28	LVDS_OUT1_AC-	Negative LVDS clock for A channel
29	GND	Ground
30	LVDS_OUT1_A2+	Positive differential LVDS data bit A2
31	LVDS_OUT1_A2-	Negative differential LVDS data bit A2
32	LVDS_OUT1_A1+	Positive differential LVDS data bit A1
33	LVDS_OUT1_A1-	Negative differential LVDS data bit A1
34	LVDS_OUT1_A0+	Positive differential LVDS data bit A0
35	LVDS_OUT1_A0-	Negative differential LVDS data bit A0
36	GND	Ground
37	LVDS_OUT1_B4+	Positive differential LVDS data bit B4
38	LVDS_OUT1_B4-	Negative differential LVDS data bit B4
39	LVDS_OUT1_B3+	Positive differential LVDS data bit B3
40	LVDS_OUT1_B3-	Negative differential LVDS data bit B3
41	GND	Ground
42	LVDS_OUT1_BC+	Positive LVDS clock for B channel
43	LVDS_OUT1_BC-	Negative LVDS clock for B channel
44	GND	Ground
45	LVDS_OUT1_B2+	Positive differential LVDS data bit B2
46	LVDS_OUT1_B2-	Negative differential LVDS data bit B2

Specifications subject to change without notice

47	LVDS_OUT1_B1+	Positive differential LVDS data bit B1
48	LVDS_OUT1_B1-	Negative differential LVDS data bit B1
49	LVDS_OUT1_B0+	Positive differential LVDS data bit B0
50	LVDS_OUT1_B0-	Negative differential LVDS data bit B0
51	GND	Ground

LED1 – Status LED connector: JST 3-way, B3B-XH-A compatible (Mating type : XHP-3 or compatible)

PIN	DESCRIPTION
1	Green LED pin (anode)
2	LED pin common (cathode)
3	Red LED pin (anode)

P1 - Analog VGA in - 15 way connector

PIN	SYMBOL	DESCRIPTION
1	PCR	Red, analog
2	PCG	Green, analog
3	PCB	Blue analog
4	ID2	Reserved for monitor ID bit 2 (grounded)
5	DGND	Digital ground
6	AGND	Analog ground red
7	AGND	Analog ground green
8	AGND	Analog ground blue
9	DDC_5V	+5V power supply for DDC (optional)
10	DGND	Digital ground
11	ID0	Reserved for monitor ID bit 0 (grounded)
12	DDC_SDA	DDC serial data
13	HS_IN	Horizontal sync or composite sync, input
14	VS_IN	Vertical sync, input
15	DDC_SCL	DDC serial clock

P2 – DVI-D input

PIN	SYMBOL	DESCRIPTION
1	/RX2	TMDS Data 2-
2	RX2	TMDS Data 2+
3	GND	Digital Ground
4	NC	No connection
5	NC	No connection
6	DDC_CLK	DDC Clock
7	DDC_DAT	DDC Data
8	VS_IN	Analog vertical Sync
9	/RX1	TMDS Data 1-
10	RX1	TMDS Data 1+
11	GND	Digital Ground
12	NC	No connection
13	NC	No connection
14	DDC_5V	+5V power supply for DDC (optional)
15	GND	Ground (+5, Analog H/V Sync)
16	HPD	Hot Plug Detect
17	/RX0	TMDS Data 0-
18	RX0	TMDS Data 0+
19	GND	Digital Ground
20	NC	No connection
21	NC	No connection
22	GND	Digital Ground
23	RXC	TMDS Clock+
24	/RXC	TMDS Clock-
C1	R	Red
C2	G	Green
C3	B	Blue
C4	HS_IN	Analog horizontal sync
C5	GND	Ground
C6	NC	No connection

P3 – HDMI 1 connector

PIN	SYMBOL	DESCRIPTION
1	DATA2+	TMDS Data2+
2	DATA2S	TMDS Data2 Shield
3	DATA2-	TMDS Data2-
4	DATA1+	TMDS Data1+
5	DATA1S	TMDS Data1 Shield
6	DATA1-	TMDS Data1-
7	DATA0+	TMDS Data0+
8	DATA0S	TMDS Data0 Shield
9	DATA0-	TMDS Data0-
10	CLK+	TMDS Clock+
11	CLK@	TMDS Clock Shield
12	CLK-	TMDS Clock-
13	CEC	CEC
14	NC	No connection
15	SCL	SCL (I ² C Serial Clock for DDC)
16	SDA	SDA (I ² C Serial Data Line for DDC)
17	CEC/GND	Ground
18	+5V	+5 V Power (max 50 mA)
19	HPDET	Hot Plug Detect

P5 – USB connector: JST B4B-PH-K compatible (Matching type : PHR-4)

PIN	DESCRIPTION
1	+5V
2	USB Data -
3	USB Data +
4	Ground

PP2 – Alternate 12V/24VDC input power supply - DC power Molex 2 pin 0.156" pitch compatible

PIN	DESCRIPTION
1	+12VDC / +24VDC in
2	Ground

PP4 – External panel power input- Molex 43045-0400 compatible (Mating type : Molex 43025-0400 or compatible)

PIN	DESCRIPTION
1	External panel power
2	Ground
3	External panel power
4	Ground

PP5 – 12V/24VDC input power supply - Molex 43650-0200 compatible (Mating type : Molex 43645-0200 or compatible)

PIN	DESCRIPTION
1	+12V / +24VDC
2	Ground

CONTROLLER DIMENSIONS

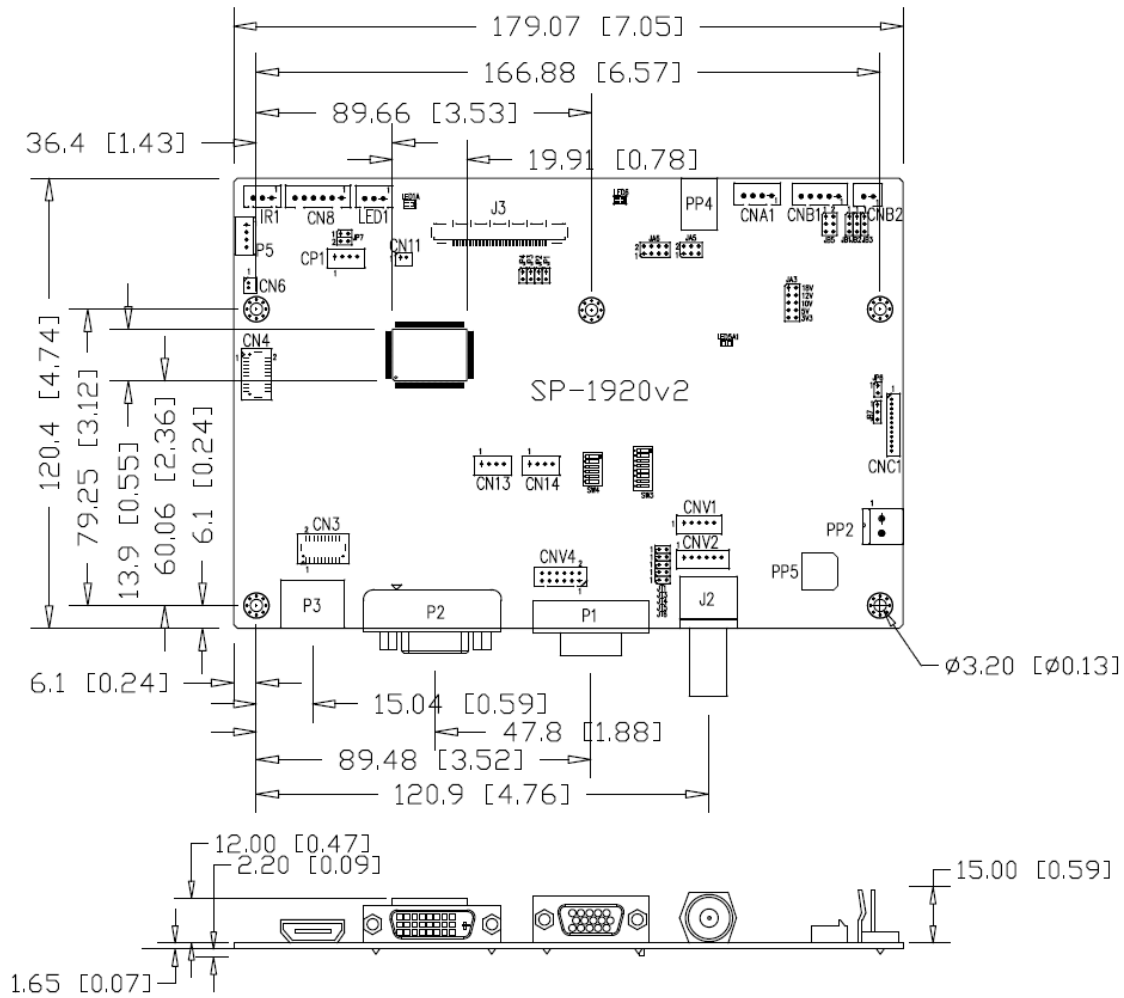

Ready-made 3D Pro-E (SLDPRT) drawing files - Save time and effort for your system volumetric analysis design. Includes jpg file previews. Please go to download at <http://www.digitalview.com/products/sp-1920v2-lcd-controller>

The maximum thickness of the controller is 18.9 mm with or without video add-on board (measured from bottom of PCB to top of components, including any underside components & leads). We recommend clearances of:

- 5mm from bottom of PCB - if mounting on a metal plate we also recommend a layer of suitable insulation material is added to the mounting plate surface.
- 10mm above the components
- 3~5mm around the edges

Any of the holes shown above can be used for mounting the PCB, they are 3.2mm in diameter.

CAUTION: Ensure adequate insulation is provided for all areas of the PCB with special attention to high voltage parts such as the inverter.

APPLICATION NOTES

USING THE CONTROLLER WITHOUT BUTTONS ATTACHED

This is very straightforward:

- Firstly setup the controller/display system with the buttons. With controls attached and display system active make any settings for colour, tint and image position as required then switch everything off.
- Remove the control switches, the 12-way (CNC1) cable.
- Short JP6 jumper to default power on the board once connected to the power.
- Refer to inverter specifications for details as to fixing brightness to a desired level, this may require a resistor, an open circuit or closed circuit depending on inverter.

Summary: On CNC1 the only pins that are used are for On/Off and Brightness (if controller mounted inverter is used). On CNC1 the pins are for momentary type buttons so it doesn't matter that no buttons are attached.

INVERTER CONNECTION

There are potentially 3 issues to consider with inverter connection:

- Power
- Enable
- Brightness

Please read the following sections for a guide to these issues.

Inverter Power: As per the table for CNB1 pin 1 is ground and pin 2 provides 12V/24V DC. This should be matched with the inverter specification: see table.

CNB1	
PIN	DESCRIPTION
1	Ground
2	+12V/+24VDC

Remark: For higher power inverter, more current (for 12V/24V) can be taken from CNA1 pin 1.

Enable: This is a pin provided on some inverters for On/Off function and is used by this panel controller for VESA DPMS compliance. If the inverter does not have an enable pin or the enable pin is not used then DPMS will not be operational. Pin 3 should be matched to the inverters specification for the 'enable' or 'disable' pin.

CNB1	
PIN	DESCRIPTION
3	Enable

Further, jumpers JB2 & JB3 should be set to match the inverters specification for the enable pin power and High or Low setting: see table.

Ref	Purpose	Note
JB2	Inverter enable voltage	1-2 H = 3.3VV, 2-3 H = 5V (Vcc), OPEN H = open collector
JB3	Inverter control	1-2 H = On, 2-3 L = On

Brightness: There are various methods for brightness control and it is important to consider the specifications for the inverter to be used. Generally the situation is:

- Brightness can control by using a resistor or VR (Variable Resistor).
- Brightness controlled by adding a circuit such as PWM (Pulse Width Modulation).
- No adjustment of brightness is possible.

CNB1 pins 4 & 5 are available for connecting to an inverter or circuit where VR control is supported.

CNB1	
PIN	DESCRIPTION
4	VR WIP
5	VR A

This can then be matched with function controls connected to CNC1 pins 4 & 3 or 5: see table.

CNC1	
PIN	DESCRIPTION
3	VR A
4	VR WIP
5	VR B

Specifications subject to change without notice

Design Guideline for making VR circuitry :

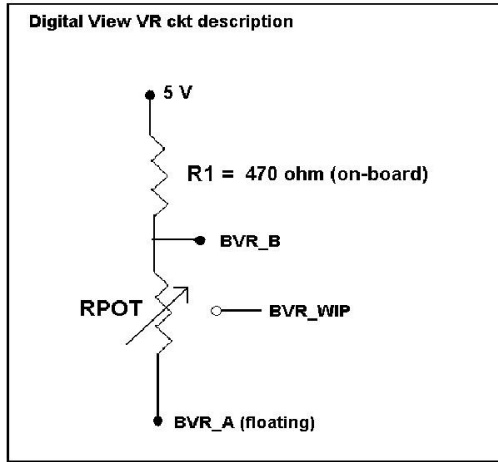

Signal description / Notes :

- 1) R1 : 470ohm on board
 - 2) RPOT is an external potentiometer (in-line dip style) that can be plugged directly into CNC1 pins 3,4,5. RPOT must be supplied / installed by user.
 - 3) BVR_B : Voltage tapped from “top” of potentiometer, the node of R1 and RPOT.
 - 4) BVR_WIP : Voltage tapped from wiper arm of RPOT.
 - 5) BVR_A : Voltage tapped from “bottom” of RPOT.
- Note : BVR_A voltage is left floating on the controller board. To use this circuit, you need to tie this point to a potential (usually GND, available at CNC1 pin 6).**

CNB1 – Backlight inverter connector: JST B5B-XH-A (Matching type : XHP-5)

PIN	SYMBOL	DESCRIPTION
1	GND	Ground
2	VBKL	+12V/24VDC, backlight power supply
3	BLCTRL	On/Off control (enable) – see JB2 & JB3
4	BVR_WIP	Brightness VR - WIP
5	BVR_A	Brightness VR A

CNC1 – Control switch, JST B12B-XH-A (Matching type : XHP-12)

PIN	SYMBOL	DESCRIPTION
1	PSWIN	Power button A
2	SW_ON	Power button B
3	BVR_A	Backlight Brightness VR pin A
4	BVR_WIP	Backlight Brightness R pin WIP
5	BVR_B	Backlight Brightness VR pin B (470 ohm resistor to +5V Vcc)
6	GND	Ground
7	MENU	OSD menu
8	-/LEFT	OSD -/Left
9	+ /RIGHT	OSD +/Right
10	SEL_DN	OSD Select down
11	SEL_UP	OSD Select up
12	NC	No connection

The VR for brightness depends on the inverter. The main power load for On/Off is handled by a relay on the controller.

Example for circuit design :

- 1.) Choose RPOT = 10K
- 2.) Tie BVR_A to GND
- 3.) Circuit analysis gives BVR_WIP as the following (see Figure 1)

$$BVR_WIP = 5 \times (Rbc/10.47)$$

where BVR_WIP is in Volts.
And Rbc is the resistance from the wiper arm to bottom of pot in Kohms.

To evaluate, plug in different values of Rbc :

Rbc	BVR_WIP
0	0 V
2.5 K	1.2 V
5 K	2.4 V
7.5 K	3.6 V
10 K	4.8 V

So this circuit could provide Brightness adjust voltage ranging from 0V to 5V.

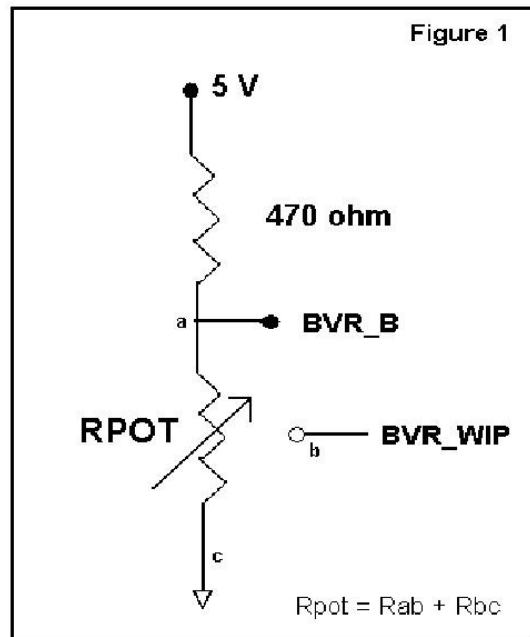

Specifications subject to change without notice

TROUBLESHOOTING

General

A general guide to troubleshooting a flat panel display system it is worth considering the system as separate elements, such as:

- Controller (jumpers, PC settings)
- Panel (controller, cabling, connection, panel, PC settings)
- Backlight (inverter, cabling, backlight tubes)
- Cabling
- Computer system (display settings, operating system)

Through step by step cross checking with instruction manuals and a process of elimination to isolate the problem it is usually possible to clearly identify the problem area.

No image:

- If the panel backlight is not working it may still be possible to just see some image on the display.
- A lack of image is most likely to be caused by incorrect connection, lack of power, failure to provide a signal or incorrect graphic card settings.

Image position:

If it is impossible to position the image correctly, i.e. the image adjustment controls will not move the image far enough, then test using another graphics card. This situation can occur with a custom graphics card that is not close to standard timings or if something is in the graphics line that may be affecting the signal such as a signal splitter (please note that normally a signal splitter will not have any adverse effect).

Image appearance:

- A faulty panel can have blank lines, failed sections, flickering or flashing display
- Incorrect graphics card refresh rate, resolution or interlaced mode will probably cause the image to be the wrong size, to scroll, flicker badly or possibly even no image.
- Incorrect jumper settings on the controller may cause everything from total failure to incorrect image. CAUTION: Do not set the panel power input incorrectly.
- Sparkling on the display: faulty panel signal cable.
- Found "Loading" message displayed on screen message at DVI input indicates the unstable DVI source detected (especially connected to DVI splitter) causing flashing image.
- No image found when non-matching video system signal input.

Backlight:

Items to check include: Power input, Controls, Inverter and Tubes generally in this order.

If half the screen is dimmer than the other half:

- Check cabling for the inverter.
- For a specific backlight tube check the AC pins orientation (CAUTION: Never reverse any DC power pins).

Also:

- If adjusting brightness control has no effect the chances are that the VR rating or method of adjusting brightness is not compatible or correctly connected to the inverter.
- If system does not power down when there is a loss of signal

Continued failure:

If unit after unit keeps failing consider and investigate whether you are short circuiting the equipment or doing something else seriously wrong.

Generally after common sense issues have been resolved we recommend step by step substitution of known working parts to isolate the problem.

SPECIFICATIONS

Panel compatibility	Compatible with 1920x1200, 1920x1080, 1680x1050, 1600x1200, 1440x900 1366x768, 1280x1024, 1024x768, 800x600 & 640x480 resolutions of TFT LCD panels. A specified BIOS and some factory adjustment may be required for individual panel timings.
No. of colours	Up to 3 x 10 bit providing 1.06 billion colors.
Panel power	DC 3.3V, 5V, 10V, 12V, 18V
Panel signal	LVDS
Vertical refresh rate	60Hz at 1920x1200, 60Hz at 1920x1080, 60Hz at UXGA and up to 75Hz other lower resolution
Display clock maximum	165MHz
ADC clock maximum	195 MHz
DVI differential input clock maximum	165MHz
Graphics formats	Standard VESA VGA, SVGA, XGA, SXGA, WXGA, UXGA, WUXGA Other special formats through specified BIOS and factory adjustment.
Graphics auto mode detect	VGA, SVGA, XGA, SXGA, WXGA, UXGA & WUXGA interlaced and non-interlaced
Standard input at source (analog RGB)	VGA analog (15 pin) standard with automatic detection of: Digital Separate Sync; Composite Sync Sync On Green.
Video formats	PAL, NTSC & SECAM
Video inputs	VGA DVI-D HDMI 1 HDMI 2 HD/SD Component video Composite video
Video output	Composite video loop out
Functions display	On screen display (OSD) of functions
OSD menu functions	Image controls: Contrast, Black level, Sharpness, Hue, Saturation, Color temperature. Other features: Image position, Size, Phase, Auto Picture Setup, Aspect Ratio, Backlight brightness adjustment, Input source select, Auto Color Gain, OSD menu transparency, OSD time out, Reset to Factory Defaults, Image orientation, Software update(USB), Auto Source Seek, Failover, Backlight Invert, Backlight control (D/A or PWM), Backlight Frequency, Minimum backlight level adjustment, Volume control.
OSD menu controls available	Power On/Off Backlight brightness (for voltage control backlight driver only) OSD Menu OSD Select up OSD Select down Setting + Setting -
Control interface	Buttons, RS-232, Remote control
Settings memory	Settings are stored in non volatile memory
PC Connectivity	VGA / SVGA / XGA / SXGA / UXGA / WUXGA analog or digital
Controller dimensions	179mm x 120.4mm (7.1" x 4.74")
Power consumption	4w approx. (not including panel power consumption)
Power load maximum	The controller has an overall 3Amp current limit.
Input voltage	12V/24VDC +/- 5%
Power protection	Fuse fitted (Non resettable type)
Storage temperature limits	-40°C to +70°C
Operating temperature limits	0°C to +60°C
Latency	12ms [#]
Use of memory on board	- 1 pc SRAM - MCU & RAM (MSD92LCBW1) on U9, 128Mbytes which is a volatile memory : SRAM for OSD and RAM for frame buffer. - 1 pc Flash - (GD25Q64) on U4, 64Mbits which is a non-volatile memory for system program. - 1 pc EEPROM - (24C02N) on U24, 2KBits which is a non-volatile memory for VGA EDID. - 1 pc EEPROM- (24C128C) on U15, 128Kbits which is a non-volatile memory for System Setting Storage.

NOTES

Please note the following:

- For specific panel setup a sample of an LCD may be required (this will be returned) and a copy of the full technical specifications for the panel from the manufacturer.
- Re-layout and custom development services are available.

Specifications subject to change without notice

- Equipment used : Leo Bodnar Electronics Video Signal Input Lag Tester. Controller input port measured based on HDMI port and connect with a Samsung LTM230HT10 (1920x1080) panel.

APPENDIX I – SIGNAL SUPPORT MODE TABLE

VGA PORT :

Resolution	Sync Mode
640x480 60Hz	Digital Separate Sync
640x480 72Hz	Digital Separate Sync
640x480 75Hz	Digital Separate Sync
800x600 56Hz	Digital Separate Sync
800x600 60Hz	Digital Separate Sync
800x600 72Hz	Digital Separate Sync
800x600 75Hz	Digital Separate Sync
1024x768 60Hz	Digital Separate Sync
1024x768 70Hz	Digital Separate Sync
1024x768 75Hz	Digital Separate Sync
1280x768 60Hz	Digital Separate Sync
1280x768 75Hz	Digital Separate Sync
1280x800 60Hz	Digital Separate Sync
1280x1024 60Hz	Digital Separate Sync
1280x1024 75Hz	Digital Separate Sync
1360x768 60Hz	Digital Separate Sync
1440x900 60Hz	Digital Separate Sync
1440x900 75Hz	Digital Separate Sync
1600x1200 60Hz	Digital Separate Sync
1600x1200 65Hz	Digital Separate Sync
1600x1200 70Hz	Digital Separate Sync
1600x1200 75Hz	Digital Separate Sync
1680x1050 60Hz	Digital Separate Sync
1920x1080 60Hz	Digital Separate Sync
1920x1080 60Hz (Reduced blanking)	Digital Separate Sync
1920x1200 60Hz	Digital Separate Sync

Remark :

The controller has been designed to take a very wide range of input signals however to optimize the PC's graphics performance we recommend choosing 60Hz vertical refresh rate. To support on higher refresh rate over 60Hz, the LCD panel may not support.

HDMI PORT :

Resolution
640x480 60Hz
640x480 72Hz
640x480 75Hz
800x600 56Hz
800x600 60Hz
800x600 72Hz
800x600 75Hz
1024x768 60Hz
1024x768 70Hz
1024x768 75Hz
1280x768 60Hz
1280x768 75Hz
1280x800 60Hz
1280x800 75Hz
1280x1024 60Hz
1280x1024 75Hz
1360x768 60Hz
1366x768 60Hz
1440x900 60Hz
1440x900 75Hz
1600x1200 60Hz
1600x1200 65Hz
1600x1200 70Hz
1600x1200 75Hz
1680x1050 60Hz
1680x1050 75Hz
1920x1080 60Hz
1920x1200 60Hz

Resolution
480i30
480p60
480p59.94
576i25
576p50
720p60
720p59.94
720p50
720p30
720p29.97
720p25
720p24
720p23.976
1080i30
1080i29.97
1080i25
1080p60
1080p59.94
1080p50
1080p30
1080p29.97
1080p25
1080p24
1080p23.976

COMPOSITE INPUT PORT :

Mode
NTSC-M
NTSC-J
NTSC-4.43
PAL-BDGI
PAL-M
PAL-N
PAL-60

DVI PORT :

Resolution
640x480 60Hz
640x480 72Hz
640x480 75Hz
800x600 56Hz
800x600 60Hz
800x600 72Hz
800x600 75Hz
1024x768 60Hz
1024x768 70Hz
1024x768 75Hz
1280x768 60Hz
1280x768 75Hz
1280x800 60Hz
1280x800 75Hz
1280x1024 60Hz
1280x1024 75Hz
1360x768 60Hz
1366x768 60Hz
1440x900 60Hz
1440x900 75Hz
1600x1200 60Hz
1600x1200 65Hz
1600x1200 70Hz
1600x1200 75Hz
1680x1050 60Hz
1680x1050 75Hz
1920x1080 60Hz
1920x1200 60Hz

COMPONENT PORT :

Mode
NTSC
PAL
576p50
480p60
480p59.94
720p60
720p59.94
720p50
1080p30
1080p29.97
1080p60
1080p59.94
1080p50
1080p30
1080p29.97
1080p25
1080p24
1080p23.976
1080i60
1080i59.94
1080i50

Appendix II – RS-232 control protocols

RS-232 Serial control (Baud rate 9600, 8 bits, 1 stop bit and no parity)

Physical connection :

Controller side
Connector interface : CN8
Mating connector : JST XHP-6

Computer side
Connector interface : Serial port
Mating connector : DB9 Female

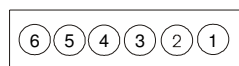

Mating face of CN8

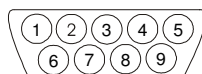

Mating face of RS-232 DB9 Male

PIN#	Description
4	RS-232 Tx Data
5	Ground
6	RS-232 Rx Data

PIN#	Description
2	RS-232 Rx Data
3	RS-232 Tx Data
5	Ground

Remark :

(1) : RS-232 connection cable, 600mm P/N 4260902-00 can be ordered separately for connection.

Software connection :

The OSD function can be controlled through sending the RS-232 protocol.

The RS-232 program can be custom-made to fit for application or it can be used the serial control program, like Accessport, Telix or Serial Utility program developed by DigitalView. Please contact your local support for information.

1. Commands to implement switch mount control buttons

Function	Command	Description	Remark
Menu button	0xf7	Menu button pressed	Button equivalent
Select-down button	0xfa	Select-down button pressed	Button equivalent
Select-up button	0xfb	Select-up button pressed	Button equivalent
Right/+ button	0xfc	Right/+ button pressed	Button equivalent
Left/- button	0xfd	Left/- button pressed	Button equivalent

2. Parameter setting - immediate, relative, reset and query

Function	Command	Description	Acknowledge (if enabled)
Volume control - Left & right channel	0x80, "a" "A", nn "+" "-" "=" "r" "R" "?"	Set audio (L+R) volume = value/increment/decrement Display OSD indicator Reset Query	volume
Volume control - on/off (mute)	0x80, "m" "M", "0" "1" "r" "R" "O" "?"	Disable audio output. Enable audio output. Reset Disable audio output without "Mute" symbol Query	"0" - audio off (muted). "1" - audio on. "O"- audio off (without mute symbol)
Back level control	0x81, nn "+" "-" "r" "R" "?" "m" "n" "i", ss, nn "o", ss,	Set brightness = value/increment/decrement Reset Query Current Source Maximum query Minimum query Set, Source, value Query, Source	Brightness. ss - reference by Input main select(0x98) Range : "0"0"-6"4" Default : "3"2"

Specifications subject to change without notice

Contrast control - all channels	0x82, "a" "A", nn "+" "-" "r" "R" "?" "m" "n" "i", ss, nn "o", ss,	Set all contrast = value/increment/decrement Reset Query Maximum query Minimum query Set, Source, value Query, Source	Contrast All. ss - reference by Input main select(0x98) Range : "0"0"-6"4" Default : "3"2"
Saturation control	0x83, nn "+" "-" "r" "R" "?" "m" "n" "i", ss, nn "o", ss,	Set saturation = value/increment/decrement Reset Query Maximum query Minimum query Set, Source, value Query, Source	ss - reference by Input main select(0x98) Range : "0"0"-6"4" Default : "3"2"
Hue control	0x84, nn "+" "-" "r" "R" "?" "m" "n" "i", ss, nn "o", ss,	Set hue = value/increment/decrement Reset Query Maximum query Minimum query Set, Source, value Query, Source	ss - reference by Input main select(0x98) Range : "0"0"-6"4" Default : "3"2"
Phase (tuning) control	0x85, nn "+" "-" "?"	Set dot clock phase = value/increment/decrement Query	Dot clock phase. (In PC mode only)
Image H position	0x86, nnnn "+" "-" "?"	Set img_hpos = value/increment/decrement Query	Image horizontal position. (In PC mode only)
Image V position	0x87, nnnn "+" "-" "?"	Set img_vpos = value/increment/decrement Query	Image vertical position. (In PC mode only)
Sharpness	0x8a, n "+" "-" "r" "R" "?"	Set sharpness = value/increment/decrement Reset Query	Sharpness. (HDMI and Composite Only) Range : "0"0"-6"4" Default : "3"2"
Clock	0x8b, nnnn "+" "-" "?"	Set frequency = Value/increment/decrement Query	Graphic mode H active size (in pixels)
Scaling Mode	0x8c,	Set graphic image scaling mode	Image expansion on/off.

Specifications subject to change without notice

	"0" "1" "9" "A" "r" "R" "?"	= value Reset Query	"0" – 1:1 "1" – fill screen "9" – 4:3 "A" – 16:9
Set display orientation	0x8e, n "r" "R" "?"	Set display orientation = value/increment/decrement Reset Query	"0" – Normal. "1" – Vertical Flip. "2" – Horizontal Flip. "3" – Horizontal & Vertical Flip.
OSD Transparency	0x92, n "+" "-" "r" "R" "?"	Set OSD transparency = value/increment/decrement Reset Query	OSD transparency "0"- 0% "1"- 25% "2"- 50% "3"- 75% "4"- 100%
OSD menu timeout	0x93, nn "+" "-" "r" "R" "?"	Select menu timeout = value/increment/decrement Reset Query	OSD menu timeout value. "0""0" – ON. "0""5" - 5 secs "0""F" - 15 secs "1""E" - 30 secs "2""D" - 45 secs "3""C" - 60 secs
Select OSD language ⁽¹⁾	0x95, n "r" "R" "?"	Select language = English, French, Spanish Reset Query	"0" – English. "2" – French. "3" – Spanish.
Input main select	0x98, nn "+" "-" "r" "R" "?"	Select input main = PC or VIDEO or next available Reset Query	Main selected. "0x41,0x31" VGA "0x42,0x31" Composite "0x44,0x31" Component "0x46,0x31" DVI "0x48,0x31" HDMI1 "0x48,0x32" HDMI2
Auto Source Seek	0x99, "0" "1" "?"	Disable/ Enable Query	"0" – Disable "1" – Enable
Failover off/on selection	0x99, nn , "0" "1" "?"	Set FailOver enable Source Disable/ Enable Query	"nn" = "0x59,0x31" FailOver
Gamma value select	0x9d, n "r" "R" "?"	Select GAMMA value = Value Reset Query	GAMMA value: "5" – 1.8, "7" – 2.0, "2" – 2.2, "A" – 2.4, "C" – 2.6
Auto power off	0x9f, "0" "1" "r" "R" "?"	Set power down option = On/Off Reset Query	"0" – Off. "1" – On.
Hotkey 1	0xa0, "1", n "r" "R" "?"	Set Hotkey 1= Value Reset Query	"1" – Volume. "2" – Back Level. "3" – Contrast. "4" – Saturation. "5" – Input source. "B" – No function "E" – Aspect/Size "F" – Image Orientation "H" – Brightness "I" – Auto Picture Setup
Hotkey 2	0xa0, "2", n "r" "R" "?"	Set Hotkey 2= Value Reset Query	"1" – Volume. "2" – Back Level. "3" – Contrast. "4" – Saturation.

Specifications subject to change without notice

			<p>“5” – Input source. “B” – No function “E” – Aspect/Size “F” – Image Orientation “H” –Brightness “I” –Auto Picture Setup</p>
Runtime counter	0xa1, nnnn “r” “R” “?”	runtime counter value = nnnn (* 0.5 hour) Reset Query	Runtime = nnnn.
Colour temperature select	0xb3, n “r” “R” “?”	Select colour temperature = value Reset Query	Main selected. “2” – 6500K. “3” – 5000K. “4” – user defined RGB values “5” – 9300K “6” – 7500K.(Default)
Red level for selected colour temperature	0xb4, nn “+” “-” “r” “R” “?”	Set the level of the red channel for the selected colour temp. = value/increment/decrement Reset Query	Red level for selected colour temperature. Range: “0”0”-“F”F” Default: “8”0”
Green level for selected colour temperature	0xb5, nn “+” “-” “r” “R” “?”	Set the level of the green channel for the selected colour temp. = value/increment/decrement Reset Query	Green level for selected colour temperature. Range: “0”0”-“F”F” Default: “8”0”
Blue level for selected colour temperature	0xb6, nn “+” “-” “r” “R” “?”	Set the level of the blue channel for the selected colour temp. = value/increment/decrement Reset Query	Blue level for selected colour temperature. Range: “0”0”-“F”F” Default: “8”0”
Graphic horizontal resolution enquiry	0xb7	Horizontal resolution (in pixels) in 3 digit hex number	“nnn” = horizontal resolution
Graphic vertical resolution enquiry	0xb8	Vertical resolution (in lines) in 3 digit hex number	“nnn” = vertical resolution
Graphic horizontal sync frequency	0xb9	Horizontal sync frequency (in units of 100Hz) in 3 digit hex number	“nnn” = horizontal frequency
Graphic vertical sync frequency	0xba	Vertical sync frequency (in units of Hz) in 3 digit hex number and 1 char	“nnnc” = vertical frequency nnn = 3 digit hex c= “i” or “p” interlace or Progressive
OSD turn off	0xbd	Turn off the OSD.	“0” – fail. “1” – successful.
Backlight control	0xe0, nn “+” “-” “=” “R” “r” “?”	Set Backlight = value/increment/decrement Display OSD indicator Reset Query	Backlight. Range: D/A : “0”0” ~ “6”4” 100Hz : “0”0” ~ “6”4” 120Hz : “0”0” ~ “6”4” 140Hz : “0”0” ~ “6”4” 160Hz : “0”0” ~ “6”4” 180Hz : “0”0” ~ “6”4” 200Hz : “0”0” ~ “6”4” 220Hz : “0”0” ~ “6”4” 240Hz : “0”0” ~ “6”4” 260Hz : “0”0” ~ “6”4” 280Hz : “0”0” ~ “6”4” 300Hz : “0”0” ~ “6”4” 320Hz : “0”0” ~ “6”4”

Specifications subject to change without notice

			340Hz : "0" "0" ~ "6" "4" 360Hz : "0" "0" ~ "6" "4" 380Hz : "0" "0" ~ "6" "4" 400Hz : "0" "0" ~ "6" "4" 420Hz : "0" "0" ~ "6" "4" 440Hz : "0" "0" ~ "6" "4"
Backlight D/A / PWM	0xe5 "0" "1" "R" "r" "?"	Set : PWM or D/A Reset Query	"0" – PWM "1" – D/A (Default)
OSD turn off	0xbd	Turn off the OSD.	"0" – fail. "1" – successful.
Backlight PWM Frequency	0xe6, nnn "+" "-" "R" "r" "?"	Set Backlight PWM Frequency = value/increment/decrement Reset Query	+/- 20Hz Value 100Hz : "0", "6", "4" 120Hz : "0", "7", "8" 140Hz : "0", "8", "C" 160Hz : "0", "A", "0" (Default) 180Hz : "0", "B", "4" 200Hz : "0", "C", "8" 220Hz : "0", "D", "C" 240Hz : "0", "F", "0" 260Hz : "1", "0", "4" 280Hz : "1", "1", "8" 300Hz : "1", "2", "C" 320Hz : "1", "4", "0" 340Hz : "1", "5", "4" 360Hz : "1", "6", "8" 380Hz : "1", "7", "C" 400Hz : "1", "9", "0" 420Hz : "1", "A", "4" 440Hz : "1", "B", "8"
Backlight Invert	0xe7 "0" "1" "R" "r" "?"	Set On or Off Reset Query	"0" – Off "1" – On
Minimum Backlight Value	0xee, "0x5C" nn "+" "-" "R" "r" "?"	Set Minimum Backlight value = value / increment / decrement Reset Query	Minimum Backlight value/ Range : D/A : "0" "0" ~ "3" "2" 100Hz : "0" "0" ~ "3" "2" 120Hz : "0" "0" ~ "3" "2" 140Hz : "0" "0" ~ "3" "2" 160Hz : "0" "0" ~ "3" "2" 180Hz : "0" "0" ~ "3" "2" 200Hz : "0" "0" ~ "3" "2" 220Hz : "0" "0" ~ "3" "2" 240Hz : "0" "0" ~ "3" "2" 260Hz : "0" "0" ~ "3" "2" 280Hz : "0" "0" ~ "3" "2" 300Hz : "0" "0" ~ "3" "2" 320Hz : "0" "0" ~ "3" "2" 340Hz : "0" "0" ~ "3" "0" 360Hz : "0" "0" ~ "3" "0" 380Hz : "0" "0" ~ "3" "0" 400Hz : "0" "0" ~ "3" "1" 420Hz : "0" "0" ~ "3" "1" 440Hz : "0" "0" ~ "3" "1"
Default Power	"0xee", "0x6B", "0x50" "0" "1"	Default power state after supplying power to controller Off On	"0" - default power off "1" - default power on

Specifications subject to change without notice

	"?"	Query	
--	-----	-------	--

3. Other control

Function	Command	Description	Acknowledge (if enabled)
Select RS-232 acknowledge	0xc1, "0" "1"	Disable/enable command acknowledge.	"0" – acknowledge disabled. "1" – acknowledge enabled.
Auto-setup	0xc3	Start auto-setup of current vmode.	"0" – fail. "1" – successful.
Command availability	0xc4, n	Check whether a command is available.	"0" – not available. "1" – available.
Auto-calibration	0xc5	Start auto-calibration of gain of the RGB amplifier.	"0" – fail. "1" – successful.
Soft Power On/Off	0xc8, "0" "1" "?"	Soft power off/on query	"0" - Soft power off "1" - Soft power on
Query video input status	0xc9	Query the status of the primary & pip status	"nn,nn" = input status "nn,xx" digit = primary status: "0","0" : invalid "A","1" VGA "B","1" Composite "D","1" Component "F","1" DVI "H","1" HDMI 1 "H","2" HDMI 2 "xx,nn" = PIP input status: "0","0": invalid
Query BIOS version	0xcb, "0"	Read BIOS version	BIOS version "VV.YY.ZZ" VV = V0 or E0, V0 = Release version E0 = Engineering Sample YY= Version Number ZZ= Customer Number
Query PCBA number	0xcb, "1"	Read PCBA number	"nnnnn" = PCBA number SP-1920v2= "41780"
Reset to Factory Defaults	0xce	Reset all parameters to default value	"1" – successful.
Reset to Factory Defaults with (color temp)	0xcf	Reset all parameters for all video modes to default value	"1" - successful.

The RS-232 command strings sent in one time can support up to 380 bytes via CN8 port
The RS-232 command string sent in one time can support up to 50 bytes via CN1 or J1 port.

n = 1-byte ascii-coded hex number, e.g., parameter value of 0x1 is represented by "1" (0x31).
mn or nn = 2-byte ascii-coded hex number, e.g., parameter value of 0x1e is represented by "1", "e" | "E" (0x31, 0x6e|0x4e).

Please refer to the ASCII to Hex convert table below.

Hex to ASCII conversion table

Hex	ASCII	Hex	ASCII	Hex	ASCII	Hex	ASCII
0x30	0	0x41	A	0x61	a	0x2B	+
0x31	1	0x42	B	0x62	b	0x2D	-
0x32	2	0x43	C	0x63	c	0x3F	?
0x33	3	0x44	D	0x64	d		
0x34	4	0x45	E	0x65	e		
0x35	5	0x46	F	0x66	f		
0x36	6	0x47	G	0x67	g		
0x37	7	0x48	H	0x68	h		
0x38	8	0x49	I	0x69	i		
0x39	9	0x4A	J	0x6A	j		
		0x4B	K	0x6B	k		
		0x4C	L	0x6C	l		
		0x4D	M	0x6D	m		
		0x4E	N	0x6E	n		
		0x4F	O	0x6F	o		
		0x50	P	0x70	p		
		0x51	Q	0x71	q		
		0x52	R	0x72	r		
		0x53	S	0x73	s		
		0x54	T	0x74	t		
		0x55	U	0x75	u		
		0x56	V	0x76	v		
		0x57	W	0x77	w		
		0x58	X	0x78	x		
		0x59	Y	0x79	y		
		0x5A	Z	0x7A	z		

Appendix III – Mapping definition

- Definition of Mapping A :

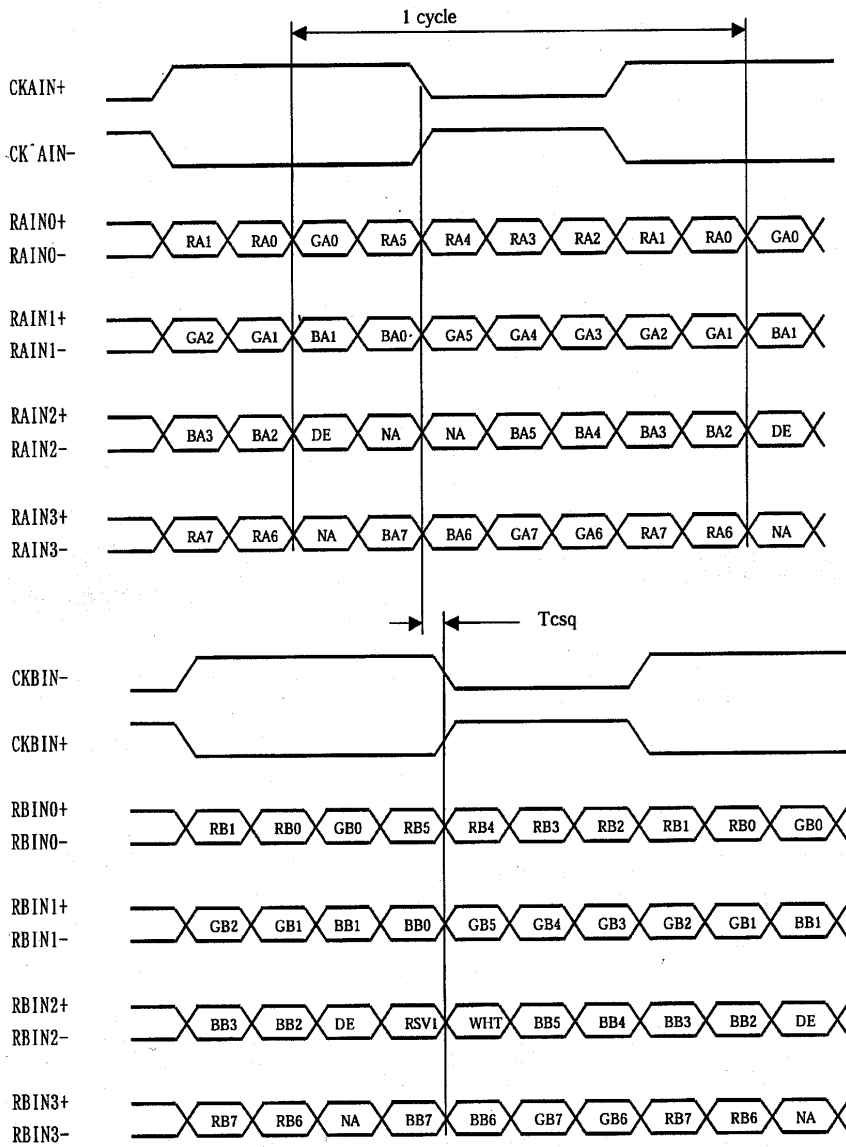

- Definition of Mapping B :

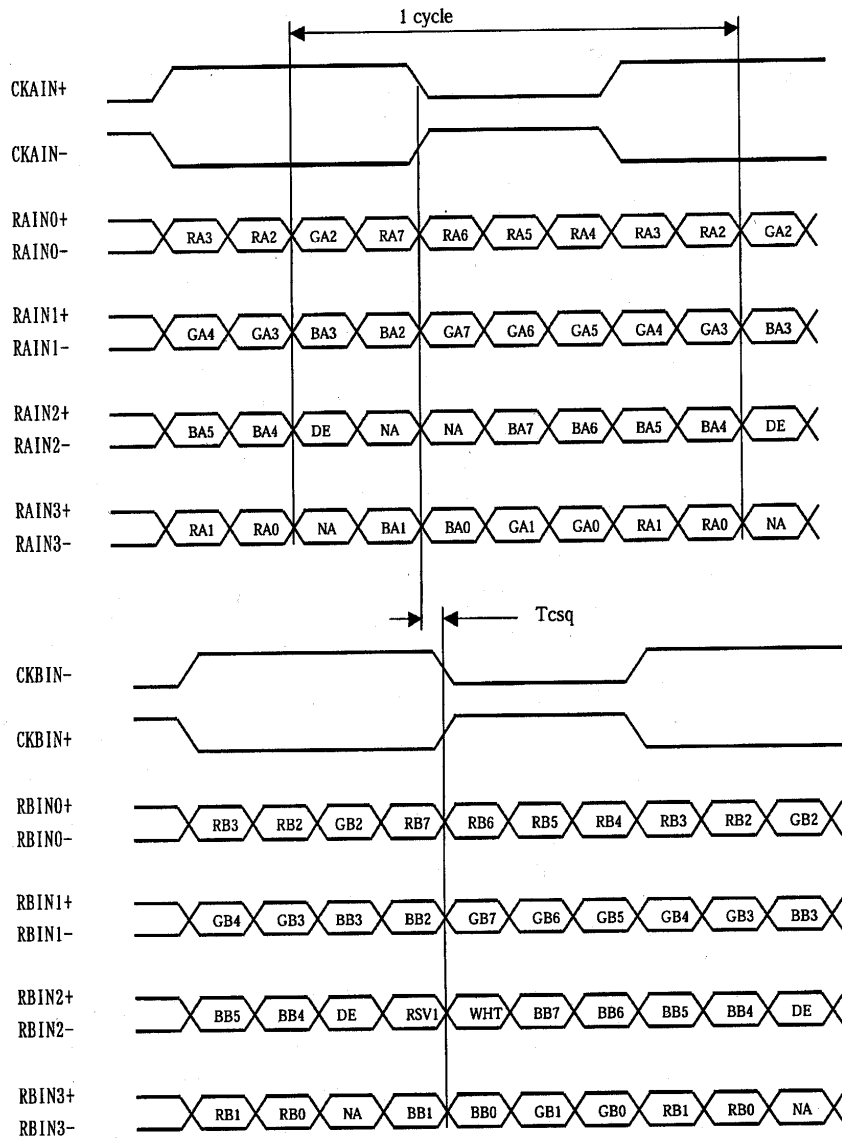

- Definition of VESA :

DPort Output Pair	Bit 6	Bit 5	Bit 4	Bit 3	Bit 2	Bit 1	Bit 0
DB[7:6] / TXDEC							
DB[3:2] / TXDE0	GE0	RE5	RE4	RE3	RE2	RE1	RE0
DB[5:4] / TXDE1	BE1	BE0	GE5	GE4	GE3	GE2	GE1
DB[9:8] / TXDE2	EN	VS	HS	BE5	BE4	BE3	BE2
DG[3:2] / TXDE3	field/prg	BE7	BE6	GE7	GE6	RE7	RE6
DG[5:4] / TXDE4	low	BE9	BE8	GE9	GE8	RE9	RE8
DG[7:6] / TXDO0	GO0	RO5	RO4	RO3	RO2	RO1	RO0
DG[9:8] / TXDO1	BO1	BO0	GO5	GO4	GO3	GO2	GO1
DR[5:4] / TXDO2	EN	VS	HS	BO5	BO4	BO3	BO2
DR[7:6] / TXDO3	field/prg	BO7	BO6	GO7	GO6	RO7	RO6
DR[9:8] / TXDO4	low	BO9	BO8	GO9	GO8	RO9	RO8
DR[3:2] / TXDOC							

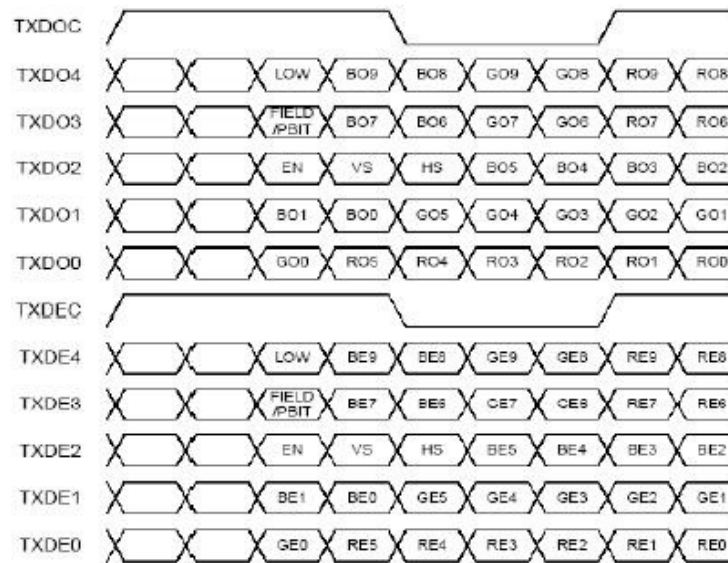

- Definition of JEIDA :

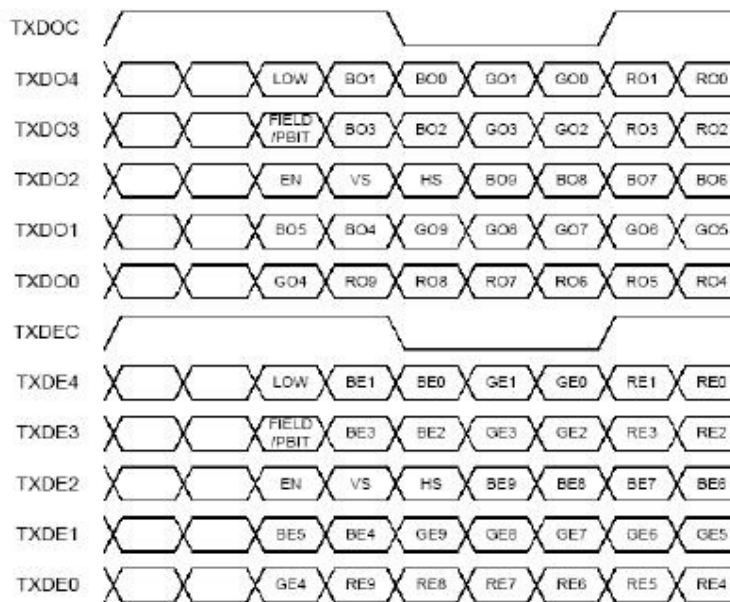

DPort Output Pair	Bit 6	Bit 5	Bit 4	Bit 3	Bit 2	Bit 1	Bit 0
DB[7:6] / TXDEC							
DB[3:2] / TXDE0	GE4	RE9	RE8	RE7	RE6	RE5	RE4
DB[5:4] / TXDE1	BE5	BE4	GE9	GE8	GE7	GE6	GE5
DB[9:8] / TXDE2	EN	VS	HS	BE9	BE8	BE7	BE6
DG[3:2] / TXDE3	field/prg	BE3	BE2	GE3	GE2	RE3	RE2
DG[5:4] / TXDE4	low	BE1	BE0	GE1	GE0	RE1	RE0
DG[7:6] / TXDO0	GO4	RO9	RO8	RO7	RO6	RO5	RO4
DG[9:8] / TXDO1	BO5	BO4	GO9	GO8	GO7	GO6	GO5
DR[5:4] / TXDO2	EN	VS	HS	BO9	BO8	BO7	BO6
DR[7:6] / TXDO3	field/prg	BO3	BO2	GO3	GO2	RO3	RO2
DR[9:8] / TXDO4	low	BO1	BO0	GO1	GO0	RO1	RO0
DR[3:2] / TXDOC							



Appendix IV – DV remote control unit work for SP-1920v2

P/N 559000106-3 :
DigitalView remote control unit
(without DV logo silk screen
printing)



BUTTON	FUNCTION
POWER BUTTON	Soft power ON/OFF button.
MUTE BUTTON ()	Switch to mute on/off mode.
SEL UP () / SEL DN ()	In OSD menu, pressing this button to select the items.
+ / - BUTTON	In OSD menu, pressing this button to adjust the settings.
OSD BACK BUTTON	Use to display the OSD menu and go to the previous OSD screen.
OSD NEXT BUTTON	Use to display the OSD menu and go to the next OSD screen.
AV/TV BUTTON	Use to select the input source. (VGA/DVI/..)
VOLUME (-/+) BUTTON	Press the "+" button to increase the volume and the "-" to decrease the volume.
PLAY (YPbPr) BUTTON	Press this button in the non OSD menu display mode to select Component source.
STOP (VGA) BUTTON	Press this button in the non OSD menu display mode to select VGA source.
DVI BUTTON	Press this button in the non OSD menu display mode to select DVI source.
HDMI	Press this button in the non OSD menu display mode to select HDMI 1 source.
Composite	Press this button in the non OSD menu display mode to select Composite source.

Appendix V – Light Sensor Function work for SP-1920v2

SP-1920v2 provides an interface to enable automatic backlight adjustment. It is possible to connect with a light sensor directly to the controller board.

Use of the light sensor board P/N 416021310/416021330-3 and light sensor cable P/N 426305900-3 connect to the SP-1920v2 via CN6 connector or use the light sensor cable P/N 426321940-3 as shown below :

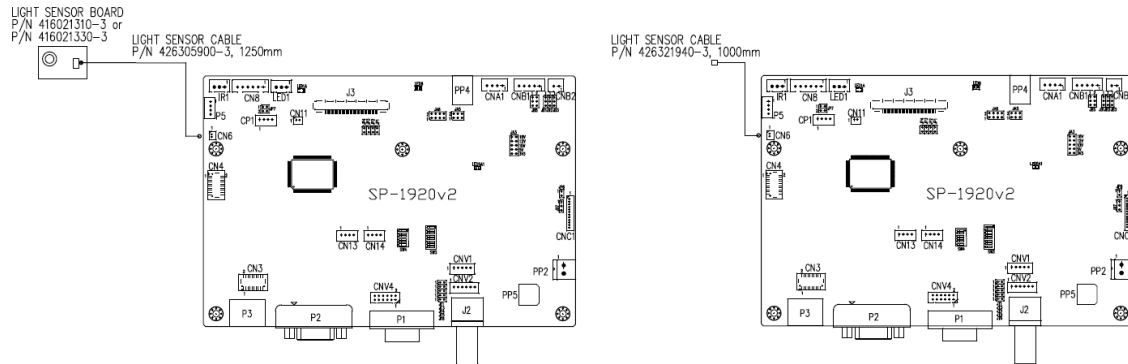

Digital View provides a user-friendly software program (TCP/IP Serial Utility V1.16 or later revision) can set thresholds for ambient light and the LCD panel backlight adjustment.

The settings can be Open/Save as by file.

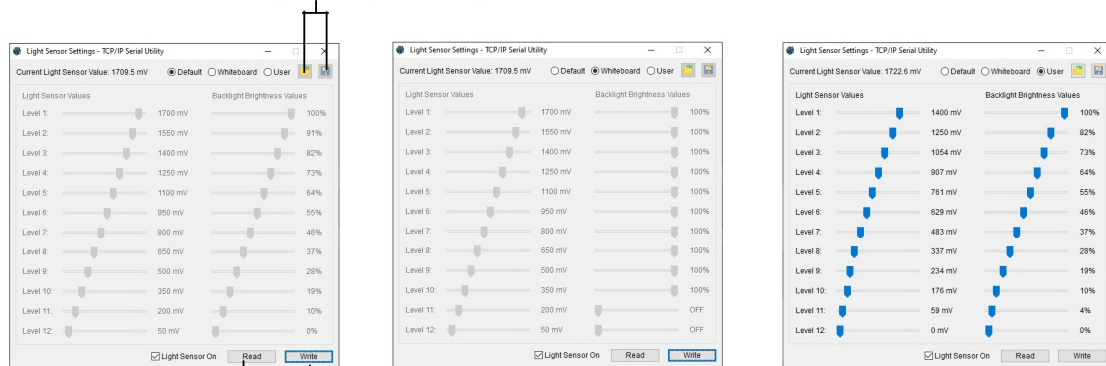

Read the current settings from controller

Confirm to write the current onto controller

Three auto dimming modes:

- Default - All the dimming level are preset as linear backlight %.
- Whiteboard - When room light 'ON', set backlight 100%, otherwise 'OFF' the backlight.
- User - Only this mode can be user configurable.

When designing a monitor a light sensor can be placed in a suitable location to detect changes in lighting and adjust the LCD panel backlight brightness appropriately.

Appendix VI – Media Failover Function

SP-1920v2 has a capability to play media file via USB that this feature called 'Media failover' option. It means when the video input source is no signal / loss of sync on a designated input, the built-in media player display the video content stored in the USB memory stick on the display automatically.

STEP 1 : To enable the Media Failover function on the OSD menu under 'Setup' page > 'Fail Over' to 'ON' as shown below :

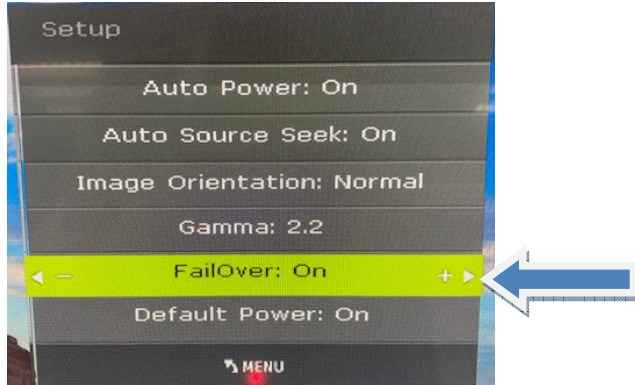

STEP 2 : Stored the media content in the following format in the USB memory stick and

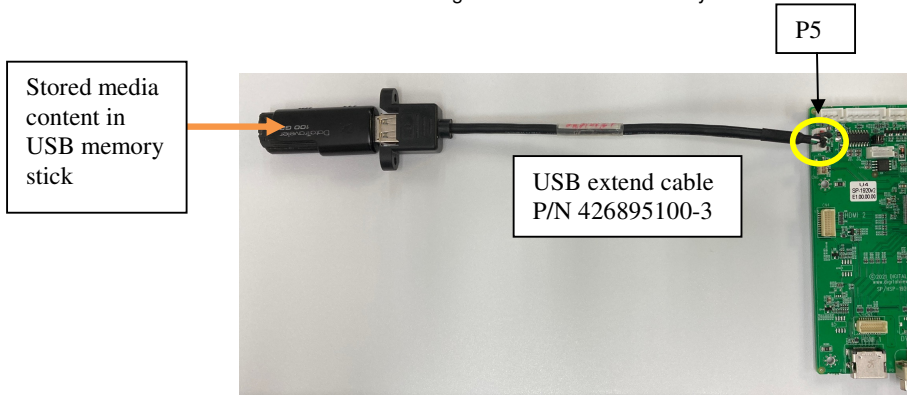

Supported media format file : "MP4"

STEP 3 : The built-in media player will run and display the video content stored in the USB memory stick automatically if the video input source is no signal / loss of sync on a designated input.

Note: It will not automatically change to any input that it must be selected via OSD button or serial command or power cycle the controller.

STEP 4 : If you want to go back to display the last input signal such as HDMI, press 'MENU' button on the OSD switch mount as it will also trigger to display the OSD menu. Or just power cycle the controller to switch back.

Appendix VII – Port switching time

Port switching time from other input port	Second (approx)
To : VGA	1.8
To : DVI	2.2
To : HDMI 1	2.2
To : HDMI 2	2.2
To : Composite	1.8
To : Component	1.8

Note :The port switching speed to digital ports (DVI & HDMI) depends on the signal source for the output signal time as the switching time measured based on Quantum tester (model : QD804A).

WARRANTY

The products are warranted against defects in workmanship and material for a period of three (3) year from the date of purchase provided no modifications are made to it and it is operated under normal conditions and in compliance with the instruction manual.

The warranty does not apply to:

- Product that has been installed incorrectly, this specifically includes but is not limited to cases where electrical short circuit is caused.
- Product that has been altered or repaired except by the manufacturer (or with the manufacturer's consent).
- Product that has subjected to misuse, accidents, abuse, negligence or unusual stress whether physical or electrical.
- Ordinary wear and tear.

Except for the above express warranties, the manufacturer disclaims all warranties on products furnished hereunder, including all implied warranties of merchantability and fitness for a particular application or purpose. The stated express warranties are in lieu of all obligations or liabilities on the part of the manufacturer for damages, including but not limited to special, indirect consequential damages arising out of or in connection with the use of or performance of the products.

CAUTION

Whilst care has been taken to provide as much detail as possible for use of this product it cannot be relied upon as an exhaustive source of information. This product is for use by suitably qualified persons who understand the nature of the work they are doing and are able to take suitable precautions and design and produce a product that is safe and meets regulatory requirements.

LIMITATION OF LIABILITY

The manufacturer's liability for damages to customer or others resulting from the use of any product supplied hereunder shall in no event exceed the purchase price of said product.

TRADEMARKS

The following are trademarks of Digital View Ltd:

- Digital View
- SP-1920v2

CONTACT DETAILS

Digital View has offices in Asia, Europe and USA :

USA

Digital View Inc.
18440 Technology Drive
Building 130
Morgan Hill,
California, 95037
USA

Tel: (1) 408-782 7773 **Fax:** (1) 408-782 7883

Sales: ussales@digitalview.com

EUROPE

Digital View Ltd.
The Lake House
Knebworth Park
Herts, SG3 6PY
UK

Tel: +44-(0)20-7631-2150 **Fax:** +44-(0)20-7631-2156

Sales: uksales@digitalview.com

ASIA

Digital View Ltd
Unit 705-708, 7/F Texwood Plaza
6 How Ming Street
Kwun Tong
Hong Kong

Tel: (852) 2861 3615 **Fax:** (852) 2520 2987

Sales: hksales@digitalview.com

WEBSITE

www.digitalview.com

Revision History

Date	Rev No.	Page	Summary
26 Aug 2022	1.00	All	First issued - Preliminary
20 Sept 2022	2.00	7 8-9 35 44	Final revision Page 7 : Enable Reset to Factory Defaults and soft power off and on function. - Page 8-9 : Update the OSD menu function naming and firmware revision. - Page 35 : Add 'Default power' RS-232 command - Page 44 : Update step 4.
14 Oct 2022	2.10	45	- Page 45 : Add Appendix VII for Port switching time.